



**INSTALLING, OPERATING AND
MAINTAINING**

**THE MODEL D1025 MKII
BI-DIRECTIONAL GENERATOR
FIELD REGULATOR**

INSTRUCTION MANUAL # S-276

INSTALLING, OPERATING AND MAINTAINING

THE MODEL D1025 MKII

BI-DIRECTIONAL GENERATOR

FIELD REGULATOR

REVISION: 3.1

OCTOBER 2003

IPC AUTOMATION ♦ 4615 W.PRIME PARKWAY ♦ McHENRY ♦ I.L. ♦ 60050
PHONE: (815) 759-3934 ♦ FAX: (815) 363-1641

TABLE OF CONTENTS
MODEL D1025MK II BI-DIRECTIONAL
FIELD REGULATOR

SECTION ONE	1
GENERAL INFORMATION	1
INTRODUCTION.....	1
SAFETY	2
WARRANTY.....	3
Q.C. TESTING.....	3
STORAGE	3
SECTION TWO	4
PRODUCT SPECIFICATIONS	4
GENERAL DESCRIPTION	4
CONTROL SPECIFICATIONS	4
CONTROL FEATURES OVERVIEW	5
SECTION THREE	6
THE FRONT PANEL	6
DIAGNOSTIC INDICATORS	6
STATUS INDICATORS.....	6
FAULT CONDITIONS.....	7
ADJUSTMENTS	9
<i>SPEEDS - SP1 THROUGH SP4 AND HI</i>	9
<i>ACCELERATION RATES - (ACC1, ACC2)</i>	9
<i>DECELERATION RATES - (DCC1, DCC2, DCC3)</i>	9
<i>LOOP GAIN</i>	10
<i>STABILITY GAIN</i>	10
<i>CONTRACT SPEED</i>	10
<i>ARMATURE FEEDBACK</i>	10
<i>STOP DELAY</i>	11
<i>S-SHAPED CURVE - ACC START, ACC END, DCC START, DCC END</i>	11
TEST POINTS	12
<i>REF OUT – TP1</i>	12
<i>TACH FDBK – TP2</i>	12
<i>ARM FDBK – TP3</i>	12
<i>FLD CUR – TP4</i>	12
<i>COMMON – TP5</i>	12
TRIP DISABLE	13
<i>TACH LOSS TRIP DISABLE (J7)</i>	13
<i>SPEED FAULT TRIP DISABLE (J10)</i>	13
AUTO RESET	14
AUTO/SET UP JUMPER (J8).....	14
ENABLE RELAY (EN-A, EN-C).....	14
CURRENT	15
SECTION FOUR	17
INSTALLATION INSTRUCTIONS	17

CONTROL INPUTS	17
TACHOMETER (TACH- TACH+ TACH GND).....	18
REF IN (J3-1).....	18
SPEED CONTACTS SP1 THROUGH SP4 AND HI (J3).....	18
ACCEL/DECEL CONTACTS (ACC1, ACC2, DCC1, DCC2, DCC3).....	19
CONTROL.....	19
UP/DOWN J4-6/7.....	19
RUN J4-8.....	20
RESET J4-9.....	20
REGULATOR PHYSICAL DIMENSIONS.....	20
POWER CONNECTIONS.....	21
ARMATURE INPUT (ARM-, ARM+).....	21
ENABLE RELAY (EN-A, EN-C).....	21
OVER VOLTAGE BUSS RESISTOR.....	21
AC FIELD POWER INPUT (FP1-FP2).....	21
FIELD OUTPUT (F+, F-).....	21
AC CONTROL POWER (L1, L2).....	22
EXTERNAL POWER CONNECTIONS.....	22
CUSTOMER AC FIELD POWER RELAY.....	22
SERIES FIELD RESISTOR (R3).....	22
RE-LEVELING RESISTOR (R1).....	22
SUICIDE CIRCUIT.....	23
EMERGENCY RUN CIRCUIT (ER) "OPTIONAL".....	23
SECTION FIVE.....	24
SET UP PROCEDURE.....	24
PRELIMINARY SET UP: (MG SET NOT RUNNING).....	25
A. Write the elevator speed for SP1 here: _____ FPM.....	27
E. Write the elevator speed for SP4 here: _____ FPM.....	27
SET UP: (MG SET NOT RUNNING).....	29
SET-UP (MG SET RUNNING).....	30
NORMAL RUNNING MODE.....	31
CURRENT AND CONTRACT SPEED CALIBRATION.....	31
FINE TUNING ADJUSTMENTS.....	33
SLUGGISH RESPONSE.....	33
OVERSHOOT/INSTABILITY.....	34
ZERO SPEED REGULATION.....	34
STOP DELAY.....	35
SELECTING A HIGH SPEED CURRENT LIMITING RESISTOR.....	36
DETERMINE THE VALUE OF THE HIGH SPEED CURRENT LIMITING RESISTOR.....	40
SELECTING A LEVELING/RE-LEVELING CURRENT LIMITING RESISTOR.....	41
SUICIDE CIRCUIT.....	47
SECTION SIX.....	48
TROUBLESHOOTING.....	48
CONTROL TRIPS ON DIRECTION FAULT.....	49
CONTROL TRIPS ON TACH LOSS.....	49
CONTROL TRIPS ON OVERSPEED.....	50
CONTROL TRIPS ON POWER BOARD TRIP AT CONTRACT SPEED.....	50
CONTROL TRIPS ON POWER BOARD TRIP AT LOW END OF A RUN.....	51
NO OUTPUT FROM CONTROL.....	51
CANNOT ACHIEVE CONTRACT SPEED.....	51

<i>ELEVATOR IS UNSTABLE AT HIGH SPEED</i>	<i>52</i>
<i>CAR OVERSHOOTS CONTRACT SPEED DURING ACCELERATION.....</i>	<i>52</i>
<i>SLOW RESPONSE AT HIGH SPEED.....</i>	<i>52</i>
<i>UP AND DOWN SPEEDS ARE NOT EQUAL</i>	<i>53</i>
<i>OUT OF REGULATION LIGHT FLICKERS OR STAYS ON</i>	<i>53</i>
<i>INSTABILITY AT LOW SPEED / DECELERATING INTO THE FLOOR</i>	<i>53</i>
<i>THE CAR STOPS TOO HARD / OSCILLATES AROUND ZERO SPEED.....</i>	<i>54</i>

LIST OF FIGURES
MODEL D1025MK II BI-DIRECTIONAL
FIELD REGULATOR

FIGURE ONE "S" Shaping Curves.....	11
FIGURE TWO Tach Loss Trip Disable Jumper	13
FIGURE THREE Speed Fault Trip Disable Jumper	13
FIGURE FOUR Auto/Set Up Jumper.....	14
FIGURE FIVE Speed Contact Arrangement	18
FIGURE SIX Accel/Decel Contact Arrangement	19
FIGURE SEVEN Direction/Run/Reset Contact Arrangement	19
FIGURE EIGHT Regulator Physical Dimensions.....	20
FIGURE NINE Tach Vs Reference Curves	32
FIGURE TEN Logic Selection Diagrams	54
FIGURE ELEVEN Hook Up Diagram.....	55

LIST OF TABLES
MODEL D1025MK II BI-DIRECTIONAL
FIELD REGULATOR

TABLE 1	SPEED POTENTIOMETER RANGES.....	9
TABLE 2	TRANSFORMER TAP SELECTION.....	25
TABLE 3	CONTRACT SPEED SETTINGS.....	26
TABLE 4	ESTIMATED FIELD CURRENT.....	28
TABLE 5	SELECTING A HIGH SPEED CURRENT LIMITING RESISTOR 110V TAP.....	37
TABLE 6	SELECTING A HIGH SPEED CURRENT LIMITING RESISTOR 130V TAP.....	38
TABLE 7	SELECTING A HIGH SPEED CURRENT LIMITING RESISTOR 150V TAP.....	39
TABLE 8	SELECTING A HIGH SPEED CURRENT LIMITING RESISTOR 165V TAP.....	40
TABLE 9	SELECTING A LEVELING SPEED CURRENT LIMITING RESISTOR 110V TAP.....	42
TABLE 10	SELECTING A LEVELING SPEED CURRENT LIMITING RESISTOR 130V TAP.....	43
TABLE 11	SELECTING A LEVELING SPEED CURRENT LIMITING RESISTOR 150V TAP.....	44
TABLE 12	SELECTING A LEVELING SPEED CURRENT LIMITING RESISTOR 165V TAP.....	45

SECTION ONE

GENERAL INFORMATION

INTRODUCTION

Thank you for purchasing an **IPC Automation** elevator control.

At **IPC** we are committed to designing and manufacturing high quality controls that meet or exceed our customers needs. This manual provides the information you will need in order to properly install, operate and troubleshoot the **Model D1025 MKII Bi-Directional Field Regulator**. It provides a general overview of the operation of the control, along with detailed descriptions of the diagnostic indicators, status indicators, adjustments and connections. Also included is a step by step start-up procedure, troubleshooting information, and applications. Please read this manual completely before attempting to install or operate the **Model D1025 MKII**.

Please feel free to call **IPC Automation** with any questions you may have **BEFORE** performing installation or start-up.

IPC Automation
4615 W. Prime Parkway
McHenry, Illinois 60050

Phone: (815) 759-3934
Fax: (815) 363-1641

SAFETY

There are certain fundamental warnings, which must be kept in mind at all times. These include:



THE BI-DIRECTIONAL FIELD REGULATOR SHOULD BE INSTALLED, ADJUSTED AND SERVICED BY QUALIFIED ELECTRICAL MAINTENANCE PERSONNEL FAMILIAR WITH THE CONSTRUCTION AND OPERATION OF ALL EQUIPMENT IN THE ELEVATOR SYSTEM; PERSONAL INJURY AND/OR EQUIPMENT DAMAGE MAY OCCUR IF INDIVIDUALS ARE NOT FAMILIAR WITH THE HAZARDS RESULTING FROM IMPROPER OPERATION.



THE BI-DIRECTIONAL FIELD REGULATOR IS AT LINE VOLTAGE WHEN AC POWER IS CONNECTED AND INTERNAL CAPACITORS REMAIN CHARGED AFTER POWER IS REMOVED FROM THE UNIT. IT IS IMPORTANT THAT AC POWER IS REMOVED FROM THE UNIT FOR A MINIMUM OF FIVE MINUTES BEFORE TOUCHING THE INTERNAL PARTS OF THE CONTROL. PERSONAL INJURY MAY RESULT UNLESS POWER IS REMOVED AND TIME IS ALLOWED FOR DISCHARGE.



THE USER IS RESPONSIBLE FOR CONFORMING WITH THE NATIONAL ELECTRICAL CODE WITH RESPECT TO MOTOR, CONTROLLER AND OPERATOR DEVICE INSTALLATION, WIRING AND START-UP. THE USER IS ALSO RESPONSIBLE FOR UNDERSTANDING AND APPLYING ALL OTHER APPLICABLE LOCAL CODES, WHICH GOVERN SUCH PRACTICES AS WIRING PROTECTION, GROUNDING, DISCONNECTS AND OVERCURRENT PROTECTION.



UNDER NO CIRCUMSTANCES SHOULD FIELD AC POWER BE APPLIED TO TB1 (FP1, FP2) IN THE ABSENCE OF CONTROL POWER. FIELD POWER SHOULD ALWAYS BE APPLIED AFTER CONTROL POWER HAS BEEN APPLIED AND HAS HAD SUFFICIENT TIME TO STABILIZE. THE CORRECT SEQUENCE FOR NORMAL OPERATION IS CONTROL POWER FIRST, FIELD POWER SECOND.



THE MACHINE SHOULD NEVER BE USED "IN SERVICE" WHILE ADJUSTING. THE SPEED MAY NOT BE ACCURATELY ADJUSTED AND THE TACHOMETER LOSS CIRCUIT MAY BE DISABLED. WHILE RUNNING THE CAR DURING ADJUSTMENT, KEEP A SAFE DISTANCE FROM THE TERMINAL LANDINGS, VISUALLY OBSERVING THE CAR AT ALL TIMES.

NOTE: ALL ADJUSTMENT POTENTIOMETERS ARE APPROXIMATELY TWENTY (20) TURNS WITH A CLUTCH AT THE END OF THE RANGE TO ENSURE ACCURATE ADJUSTMENT OF THE BI-DIRECTIONAL FIELD REGULATOR.

WARRANTY

Standard conditions of sale for the company include a Statement of Warranty, which covers the control equipment. This Statement of Warranty covers all new equipment.

The Model D1025 MKII Bi-Directional Field Control has been designed as a standard product to meet the general criteria for controlling a motor-generator set in conjunction with an elevator. IPC does not warrant that the control will meet all application requirements, codes and safety standards.

Q.C. TESTING

Quality is an important factor of each phase of the manufacturing and development process. Each unit must pass rigorous quality tests as well as static and dynamic performance checks and a final inspection for quality of workmanship. A unit is allowed to ship only after acceptance of all aspects of Q.C. testing and inspection. This assures that you receive only those controls that meet our demanding quality standards.

STORAGE

Please take the following precautions if it should become necessary to store the control for any length of time.

-  Store the control in a clean, dry (non-corrosive) location that is protected from sudden variations in temperature, and high levels of moisture, shock and vibration.

-  The ambient temperature where the control is stored should be maintained between zero and 65 degrees Centigrade.

-  The control should be stored in the original package to protect from dust and dirt contamination.

SECTION TWO PRODUCT SPECIFICATIONS

GENERAL DESCRIPTION

The Model D1025 MKII Bi-Directional Field Regulator was designed to control the Generator Shunt Field of a motor generator-driven geared or gearless Hoist Motor. Tachometer feedback is used to provide a closed loop speed regulated system. Armature feedback is used to provide fast response and added stability and an "S" Shaped Curve Reference is provided for smooth take offs and landings. These features combine to provide a high gain fast response system to precisely control armature voltage. The net result is precise control of the generator field current that will provide speed regulation to within point five percent (0.5%) of contract speed.

CONTROL SPECIFICATIONS

TRANSFORMER INPUT SUPPLY:	208/230 VAC, 50/60 HZ. Single phase @ 10 AMPS
CONTROL INPUT SUPPLY (L1-L2):	208/230 VAC, 50/60 HZ. Single phase @ 1 AMP
FIELD POWER SUPPLY: (FP1-FP2) ISOLATED	Adjustable at Transformer Secondary. 110/130/150/165 VAC
FIELD POWER OUTPUT (F+ - F-):	Zero (0) to +/- 230 VDC 7.5 AMPS Max.
SPEED REGULATION:	0.5% of contract speed (Subject to tachometer specifications and RPM)
RESPONSE TIME:	One millisecond (1ms)
PHYSICAL DIMENSIONS:	Length: 12.500" Width: 8.125" Height: 3.500"

CONTROL FEATURES OVERVIEW

The key features of the Model D1025 MKII Bi-Directional Field Regulator are summarized here. Like all IPC Automation Bi-Directional Regulators, the D1025 MKII offers superior control of the elevator’s speed.

- ✓ Improved Layout provides access to all test points and adjustment potentiometers
- ✓ Advanced Drive Technology provides independent device protection against phase to phase and phase to ground short circuits
- ✓ Soft Start Circuitry eliminates the need for a heavy-duty power contactor at the Field Power inputs
- ✓ Set-up mode for easy set-up and troubleshooting
- ✓ Adjustable Loop Gain allows you to customize the response of the regulator to match the system
- ✓ Four Independent S-Shape curve pattern adjustments
- ✓ Multi-turn potentiometer adjustments for accuracy
- ✓ Indicator lights for inputs and diagnostics
- ✓ Independent adjustments for:
 - Five Speed Settings
 - Two Acceleration Rates
 - Three Deceleration Rates (selectable for four rates if needed)
- ✓ Enable Relay for elevator system safety string
- ✓ Fault protection including independent indicators for each of the following:
 - Tach loss
 - Power Board Trip
 - Direction/Under Speed trip



THE FAULT CIRCUITS DESCRIBED ARE DESIGNED TO PROTECT THE CIRCUITRY AND PROVIDE INDICATION OF RELIABLE OPERATION OF THE CONTROLLER. THE FAULT CIRCUITS SHOULD NOT BE USED AS A SAFETY DEVICE FOR PROTECTING PERSONNEL. THE FAULT CIRCUITS IN THE CONTROL ARE NOT REDUNDANT CIRCUITS; THEY RELY UPON THE OPERATION OF THE CONTROL TO INDICATE FAULTY OPERATING CONDITIONS. THEREFORE, THE ELEVATOR COMPANY SHOULD ALWAYS USE REDUNDANT SAFETY DETECTORS AND BACK-UP DEVICES TO PROVIDE SAFETY FOR PERSONNEL. THE FAULT CIRCUITS ARE NOT INTENDED TO MEET ELEVATOR CODE FOR THE PROTECTION OF PERSONNEL AND SHOULD NOT BE USED TO MEET ELEVATOR CODES.

SECTION THREE THE FRONT PANEL

DIAGNOSTIC INDICATORS

The Model D1025 MKII features a variety of color-coded indication lights to allow a quick assessment of control performance and status. Green lights indicate normal functionality such as control power, field power reference input and direction. Yellow lights indicate an area of concern, such as an out of regulation condition. Red lights indicate a fault or trip condition and shut down the control.

STATUS INDICATORS

- CONTROL POWER (GREEN):** Indicates that the control power is applied, and there is sufficient voltage to operate the regulator.
- FIELD POWER (GREEN):** Indicates that the field power voltage is applied at the **FP1** and **FP2** input terminals to the field power bridge. The LED will remain lit as long as DC Buss voltage is present on the Power Board.
- UP (GREEN):** Indicates that the **UP** direction input contact is closed.
- DOWN (GREEN):** Indicates that the **DN** direction input contact is closed.
- REFERENCE (GREEN):** Indicates that a speed signal is applied to the **REF IN** terminal through the **SP1 - HI** speed contacts.
- OUT OF REG (YELLOW):** Indicates that the tachometer voltage is not equal to the reference voltage. Required speed cannot be maintained when the control is producing full output.

FAULT CONDITIONS

The control monitors certain conditions that may cause faulty operation of the machine. An instantaneous shut down will occur when a fault condition is detected. To aid in set-up and troubleshooting, the fault circuits will latch. You may reset the control after a trip condition has occurred by enabling the Auto Reset and removing the RUN signal, or by disconnecting the control power. The Tach Loss and Direction Fault trips can be disabled by moving their associated jumpers to the Disable position.

DIRECTION / UNDER SPEED (RED): The direction circuit is designed to detect when the movement of the car is different than the direction called for by the control. A direction fault will occur, for example, if the UP relay is energized and the car moves at more than 10% of contract speed in the DN direction.

The under speed detection circuit is designed to detect an under speed condition in the car. An under speed condition will occur, for example, if the UP relay is energized and a call for contract speed is initiated and the tachometer feedback signal is less than 10% of contract speed.

UNDERSPEED DISABLE: The under speed detection circuit may be disabled in order to facilitate the set-up procedure. A two-position jumper (**J10**) is located on the right side of the control board. When **J10** is shorted, an under speed condition will not shut down the control. When **J10** is not shorted, the fault trip circuit is enabled and will shut down the control when an under speed fault occurs.

TACH LOSS (RED): The Tach Loss circuit is designed to detect a complete loss of tachometer feedback voltage when the armature voltage is approximately equal to the contract loop voltage. Problems that will not be detected by this circuit such as slippage of the tach or other Tachometer malfunctions may cause a reduction in the tach feedback voltage causing an over speed condition. This circuit relies on proper setting of the armature feedback voltage. The tach loss circuit is designed to shut down the control in case of zero tachometer voltage as long as the armature voltage exceeds +/- 3 volts at the ARM FB test point.

TACH LOSS DISABLE: The Tach Loss trip circuit can be disabled, in order to facilitate the set-up procedure. A two-position jumper **J7** located on the right side of the control board is provided to disable the Tach Loss trip circuit. When the jumper is shorted, the fault trip circuit will not detect a tach loss. When the jumper is not shorted, the fault trip circuit is enabled and will shut down (trip) the control when a tach loss fault occurs.



IT IS DANGEROUS TO OPERATE THE CAR WITH THE "TACH LOSS TRIP CIRCUIT" AND ELEVATOR SAFETY SHUTDOWNS DISABLED. THE J7 TACH LOSS DISABLE JUMPER MUST NOT BE SHORTED WHEN THE CAR IS PUT INTO SERVICE.

POWER BOARD TRIP (RED): The power board trip light indicates that a trip has occurred which is directly related to the power board. The two trip conditions related to this indicator are **Over current** and **Over voltage**.

The control will trip instantaneously on over current if the current output of the control exceeds the control rating by more than 50%. The maximum current output of the control should never exceed the output rating of the control (7.5Amps) during normal operation.

The control will trip instantaneously on over voltage if the DC Field Power Buss voltage exceeds 350 Volts DC.



THE FAULT CIRCUITS AS DESCRIBED IN THE PROCEEDING SECTION ARE DESIGNED TO PROTECT THE CONTROL CIRCUITRY AND PROVIDE INDICATION OF RELIABLE OPERATION OF THE REGULATOR.

THE FAULT CIRCUITS SHOULD NOT BE USED AS A SAFETY DEVICE FOR PROTECTING PERSONNEL.

THE FAULT CIRCUITS IN THE CONTROL ARE NOT REDUNDANT; THEY MAY RELY UPON THE OPERATION OF THE CONTROL TO INDICATE FAULTY OPERATING CONDITIONS. THEREFORE, THE ELEVATOR COMPANY SHOULD ALWAYS USE REDUNDANT SAFETY DETECTORS AND BACK-UP DEVICES TO PROVIDE SAFETY FOR PERSONNEL.

THE FAULT CIRCUITS ARE NOT INTENDED TO MEET ELEVATOR CODE FOR THE PROTECTION OF PERSONNEL AND SHOULD NOT BE USED TO MEET ELEVATOR CODES.

ADJUSTMENTS

SPEEDS - SP1 THROUGH SP4 AND HI

The speed potentiometers are used to set the speeds that will be used by the elevator. All speed settings made on the Model D1025MKII will be referred to as a percentage of contract speed. The Model D1025MKII uses a speed setting of ten (10.00) volts at the **REF IN** terminal (J3-1) to represent a contract speed call. The speed potentiometer ranges are described as follows:

SPEED	RANGE OF POTENTIOMETER (% Contract Speed)	RANGE OF VOLTAGE AT REF IN TERMINAL
SP1	0 to 15%	0 to 1.50 Volts
SP2	0 to 99%	0 to 9.90 Volts
SP3	0 to 99%	0 to 9.90 Volts
SP4	0 to 99%	0 to 9.90 Volts
HI	FIXED 100%	10.00 Volts

TABLE ONE

Speed points can be preset by closing the respective speed contact and measuring the voltage at the **REF IN** terminal (J3-1).

ACCELERATION RATES - (ACC1, ACC2)

Two externally selected, independently adjusted potentiometers are provided for setting acceleration rates (**ACC1** and **ACC2**). Each has an adjustment range of one second with the potentiometer fully clockwise (CW), to ten seconds with the potentiometer fully counterclockwise (CCW). The time intervals are defined as the time it takes for the signal at the **REF OUT** testpoint (TP1) to go from zero speed to contract speed during acceleration.

DECELERATION RATES - (DCC1, DCC2, DCC3)

Three externally selected, independently adjusted potentiometers are provided for setting deceleration rates (**DCC1**, **DCC2** and **DCC3**). Each has an adjustment range of one second with the potentiometer fully clockwise (CW), to ten seconds with the potentiometer fully counterclockwise (CCW). The time intervals are defined as the time it takes for the signal at the **REF OUT** testpoint (TP1) to go from contract speed to zero speed during deceleration.

NOTE: The control is factory set to provide two acceleration rates (**ACC1, ACC2**) and three deceleration rates (**DCC1, DCC2, and DCC3**). Repositioning the mini-link jumper (**J5**) from the **ACC2** to the **DCC4** position (located on the top PC board adjacent to the ACC2/DCC4 pot) converts the ACC2 potentiometer to a fourth deceleration pot. In this position there are four decel rates (**DCC1, DCC2, DCC3, and ACC2**) and only one acceleration rate (**ACC1**).

LOOP GAIN

The **LOOP GAIN** setting determines how quickly the control will correct for errors in the speed feedback loop (TACH vs REF OUT). The **LOOP GAIN** adjustment should be used to fine-tune the system for regulation and stability. If the system tends to be too responsive, the **LOOP GAIN** should be reduced by turning the potentiometer counterclockwise (CCW). If the control is slow or sluggish to respond then the **LOOP GAIN** should be increased by turning the potentiometer clockwise (CW).

STABILITY GAIN

The **STABILITY GAIN** setting determines how quickly the control will correct for changes in the armature feedback signal versus changes in the reference signal (change in ARM FB vs change in REF OUT). This adjustment should be used to fine tune the stability of the system after the armature feedback signal has been properly adjusted. The system may be sluggish if the **STABILITY GAIN** is set too high and unstable if the **STABILITY GAIN** is set too low.

CONTRACT SPEED

The **CONTRACT SPEED** potentiometer scales the amount of tachometer feedback, which the control uses to regulate the speed of the car. This potentiometer should be adjusted so that the voltage at the **TACH FDBK** testpoint (TP2) is equal to the voltage at the **REF OUT** testpoint (TP1) while the car is running at contract speed. This adjustment assures proper calibration of the tachometer signal to the reference signal.

NOTE: The **REF OUT** and **TACH FDBK** testpoints **must** measure approximately ten (10.00) volts at contract speed for proper operation of the control.

ARMATURE FEEDBACK

The armature feedback signal is used in the stability circuitry of the D1025MKII. The **ARMATURE FEEDBACK** potentiometer should be adjusted for 7.5 volts (measured at the **ARM FDBK** testpoint [TP3]) when the car is running at contract speed. The system may be sluggish if there is too much armature feedback and over responsive if there is too little armature feedback. The armature feedback should never be set above ten (10.00) volts or below four (4.00) volts when running at contract speed.



A setting below +/- four (4.00) volts at contract speed can cause the tach loss circuit to become inoperative. Do not set the ARM FB testpoint below +/- four (4.00) volts at contract speed.

STOP DELAY

The **STOP DELAY** is initiated by opening the UP or DN contact when the RUN contact at J4-8 is energized. The **STOP DELAY** is adjustable from **0.5** seconds with the **STOP DELAY** potentiometer fully counterclockwise (CCW) to zero (0) seconds with the potentiometer fully clockwise. The REF OUT and TACH signals will continue to follow the deceleration ramp during the time delay. The REF OUT and TACH signals will rapidly discharge to zero volts at the end of the delay.

S-SHAPED CURVE - ACC START, ACC END, DCC START, DCC END

The transitional *knees* of the S-curve are independently adjustable by their associated potentiometers. A clockwise rotation (CW) will make the *knee* sharper and a counterclockwise rotation (CCW) will make the *knee* smoother.

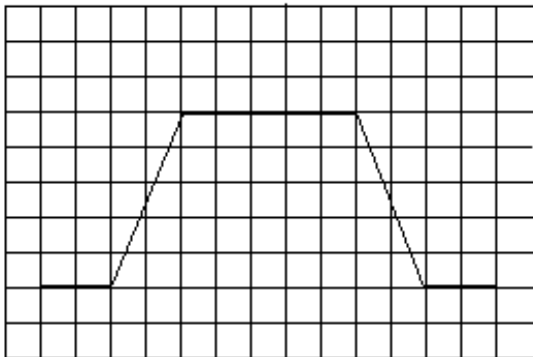
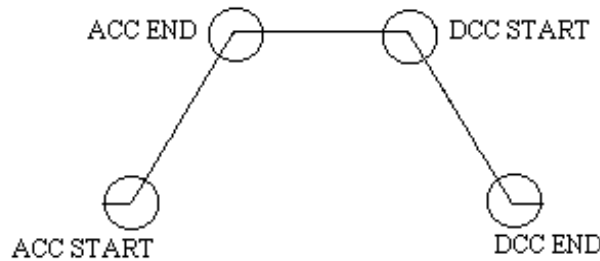

SHARP S-CURVE
ALL POTS FULL CW

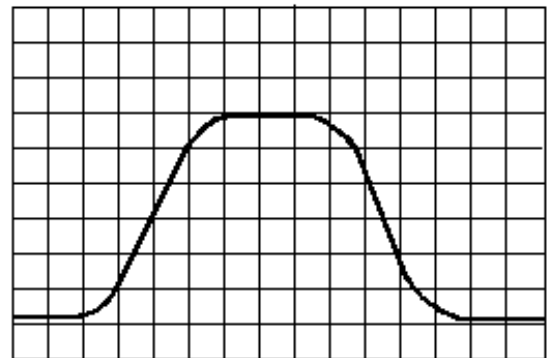

SMOOTH S-CURVE
ALL POTS FULL CCW

FIGURE ONE

TEST POINTS

Test points are available as aids for set-up, adjustment and troubleshooting of the control.

REF OUT – TP1

The REF OUT testpoint monitors the shaped reference from the S-Shaped Curve circuit, which is the ultimate reference that the system will follow. This testpoint is used to monitor the reference pattern on an oscilloscope when comparing the TACH vs REF OUT signals for fine-tuning.

TACH FDBK – TP2

This testpoint monitors the tachometer feedback. The tachometer feedback should be set to a positive ten-volt (10.00) level while the car is running at contract speed in the UP direction. This testpoint is also used to monitor the tachometer pattern on an oscilloscope.

ARM FDBK – TP3

This testpoint is used to set the scale of the armature feedback used in the stability circuits. The armature feedback should be set to a positive 7.5-volt level while the car is running at contract speed in the UP direction. The armature feedback signal may be fine-tuned for maximum stability of the system after the elevator system is fully functional. It is important that the armature feedback signal is positive in the UP direction and negative in the DN direction.



The armature feedback signal should never be set for less than four (4.00) volts at contract speed. The tach loss circuit may become inoperative if the armature feedback is set too low.

FLD CUR – TP4

The **FLD CUR** testpoint monitors field current and is calibrated so that one (1.00) volt at the testpoint is equal to 0.75 amps of field current. Like all of the other testpoints, the voltage will be positive in the UP direction and negative in the DN direction.

COMMON – TP5

All of the measurements made during the set-up and adjustment of the control should be referenced to this testpoint unless otherwise noted. The negative lead of the multimeter should be connected to this testpoint for all measurements.

TRIP DISABLE

The trip disable jumpers are available for use by the set-up person to aid in the initial set-up and inspection of the control. There are currently two disable jumpers. Each point disables an individual trip circuit.

TACH LOSS TRIP DISABLE (J7)

This point disables the **TACH LOSS** trip circuit. The **TACH LOSS** disable jumper is located on the right hand side of the control (top) board, directly to the right of R87. To disable the trip circuit, jumper the two pins of J7 together.

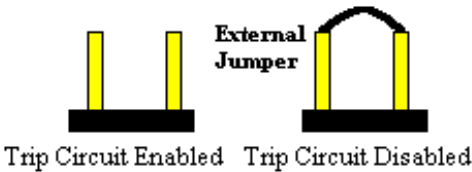

FIGURE TWO

SPEED FAULT TRIP DISABLE (J10)

The **SPEED FAULT TRIP DISABLE** jumper is located directly below the TACH LOSS TRIP DISABLE jumper. This jumper disables the DIRECTION and UNDER SPEED trip circuitry. When the jumper is shorted, the control will not trip on an UNDER SPEED or DIRECTION fault trip.

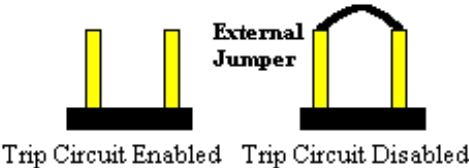

FIGURE THREE



IT IS DANGEROUS TO OPERATE THE ELEVATOR WITH THE TRIP CIRCUITS IN THE DISABLED STATE. THE DISABLE JUMPERS MUST BE REMOVED BEFORE PUTTING THE ELEVATOR IN SERVICE.

AUTO RESET

If the RESET terminal (J4-9) is tied to the CONTROL terminal (J4-5), the control will enter an AUTO RESET state. When a trip condition occurs, dropping the RUN contact (J4-8) and then reapplying the RUN contact (J4-8) will reset the trip. If you do not wish to have the control in an AUTO RESET state, do not tie the RESET terminal (J4-9) to the CONTROL terminal (J4-5). In this mode, when a trip occurs, the trip will latch and shut down the control. In order to reset the control you must drop the RUN contact (J4-8) and close a RESET contact which connects RESET (J4-9) to CONTROL (J4-5). Then you would open the RESET contact and energize the RUN contact (J4-8) to resume normal operation.

AUTO/SET UP JUMPER (J8)

The AUTO/SET UP jumper is used as a set-up and troubleshooting aid. During normal operation of the control, the jumper should be left in the AUTO position. Changing the jumper to the SET UP position will allow the elevator to run without using the tachometer feedback signal to regulate speed. This will allow the troubleshooting of tachometer signal problems, which may be the cause of poor regulation, or fault trip problems. When the control is in the SET UP mode, the speed regulation will be poor. When the control is put in the SET UP mode, you must also disable the TACH LOSS and DIRECTION/UNDER SPEED trip circuits.

NOTE: When using the control in the SET UP mode, you must also disable the TACH LOSS and SPEED FAULT trip circuits. If these circuits are not disabled while in the SET UP mode, the control will trip as soon as the car tries to move.



THE ELEVATOR SYSTEM SHOULD NEVER BE PUT IN SERVICE WITH THE CONTROL IN THE SET UP MODE.

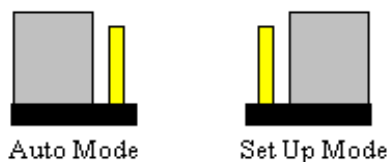

FIGURE FOUR

ENABLE RELAY (EN-A, EN-C)

A set of normally open relay contacts is available for use in the customer's enable circuitry. These contacts are located at TB1-3 and TB1-4 on the Power Board. The enable contacts will open when the control is disabled and a fault condition has occurred; and will close with no faults and AC Control Power applied. These contacts are rated for 250 VAC @ 5 amps max

CURRENT

The field current is automatically limited to 7.5A maximum. However, some points to keep in mind when setting up the control are:

1. The control cannot provide more current than the resistance of the load and bus voltage will permit. This is shown by the following formula:

$$I \text{ (max)} = [E \text{ (field power)} \times 1.4] / R \text{ (field)}$$

Example: My AC Secondary Voltage (E field power) while using the X1 to X2 tap is 110 VAC. The resistance of my field (R field) is 40 Ohms. The maximum current (I max) that the control can provide with this configuration is (110 VAC x 1.4) / 40 Ohms which equals 3.85 Amps.

2. Field connections are important to the response of the system. The lower the inductance of the field usually means the faster the response of the system. Parallel field connections are therefore desirable. However, paralleling the field windings decreases the resistance of the generator field and increases the field current for a given maximum field voltage. This may cause the current requirements of the generator field to exceed the maximum current rating of the control. MG sets with four fields can usually be connected in series parallel configuration with very good results.
3. Field voltage directly affects the field current. The maximum field voltage will be 1.4 times the secondary voltage of the field power isolation transformer connected to TB1. This voltage should be large enough to supply adequate field current under all load conditions. If an insufficient amount of field current is supplied, you will not be able to reach contract speed under full load conditions.
4. The current required for contract speed can be determined during set-up and initial test runs under **full load**. Calculate the secondary voltage for the AC Field Power Supply by using the following formula:

$$E \text{ (field power)} = [I \text{ (max)} \times R \text{ (field)}] / 1.414$$

Example: The maximum current I require with a fully loaded car in the down direction is 5 Amps. The resistance of my generator field (R field) is 34 Ohms.

I calculate my required secondary voltage to be:
5 Amps x 34 Ohms which equals 170 volts DC.

I calculate my AC voltage as 170 VDC/1.414, which equals 120.23 volts AC

The secondary voltage should be adjusted to select the nearest value transformer tap. This keeps the maximum DC field voltage within the calculated range and makes the system safer by limiting the maximum field current. In cases where the transformer tap falls between the calculated AC voltage, the next higher tap must be used to assure that contract speed is achieved under full load conditions. When this is the case, a resistance should be added in series with the shunt field to limit the field current. In the example above,

the required secondary voltage is 120.23 volts AC. The isolation transformer has taps for 110 Volts and 130 Volts AC. In this case I will want to use the 130-volt tap. This tap can be used safely by adding a resistance in series with the field. This resistance should be sized to limit the maximum field current to the value necessary to reach contract speed. The total resistance may be calculated by the following formula.

$$\mathbf{R \text{ (total)} = [E \text{ (secondary tap voltage)} \times \mathbf{1.414}] - E \text{ (field power)} / I \text{ (max)}}$$

Example: Since I have chosen to use the 130-volt AC transformer tap, I will first calculate the DC equivalent voltage by multiplying by 1.4 as follows. 130 volts AC times 1.414 equals 183.82 volts DC. Next, I will subtract the DC field power voltage calculated in step 4 above (from the transformer tap chosen). This is the voltage that must be dropped across the resistor that will be added. 183.82 volts DC minus 170 volts DC, equals 13.82 volts DC. Now I will divide this voltage by my maximum field current of 5 Amps. 13.82 volts DC divided by 5 Amps equals 2.76 Ohms. This is the value of the resistor that I should add in series with the generator field.

5. The field voltage and any added resistance will definitely affect the performance of the system. While it is good practice to limit the AC voltage to be just high enough to reach contract speed at full loads, the performance of the system may be limited under certain conditions. A low line voltage may prevent the machine from reaching contract speed. Low line voltage may also prevent fast acceleration ramps and round off the top of the curve. This low line voltage would limit the maximum current to the field, which would limit the maximum loop voltage and ultimately limit the system torque at higher speeds. On the other hand, if the voltage was too high, the control would have to limit the current and this could cause instability in the system. Therefore, we suggest that you follow a simple rule when selecting the transformer tap. ***The AC voltage tap selected on the transformer should never exceed the calculated value by more than 30 %.***

SECTION FOUR INSTALLATION INSTRUCTIONS

CONTROL INPUTS

The regulator's internal circuitry is **not** isolated from the external input contact circuitry. The contact circuitry operates from internally supplied voltages to the **REF IN** and **CONTROL** terminals. The contacts required are low voltage contacts and conduct approximately .01 amps. They should be enclosed relays with good wiping action to protect against malfunctions due to dirt or dust.



THE BI-DIRECTIONAL FIELD REGULATOR SHOULD BE INSTALLED, ADJUSTED AND SERVICED BY QUALIFIED ELECTRICAL MAINTENANCE PERSONNEL FAMILIAR WITH THE CONSTRUCTION AND OPERATION OF ALL EQUIPMENT IN THE ELEVATOR SYSTEM; PERSONAL INJURY AND/OR EQUIPMENT DAMAGE MAY OCCUR IF INDIVIDUALS ARE NOT FAMILIAR WITH THE HAZARDS RESULTING FROM IMPROPER OPERATION.



THE BI-DIRECTIONAL FIELD REGULATOR IS AT LINE VOLTAGE WHEN AC POWER IS CONNECTED AND INTERNAL CAPACITORS REMAIN CHARGED AFTER POWER IS REMOVED FROM THE UNIT. IT IS IMPORTANT THAT AC POWER IS REMOVED FROM THE UNIT FOR A MINIMUM OF FIVE MINUTES BEFORE TOUCHING THE INTERNAL PARTS OF THE CONTROL. PERSONAL INJURY MAY RESULT UNLESS POWER IS REMOVED AND TIME IS ALLOWED FOR DISCHARGE.



THE USER IS RESPONSIBLE FOR CONFORMING TO THE NATIONAL ELECTRICAL CODE WITH RESPECT TO MOTOR, CONTROLLER AND OPERATOR DEVICE INSTALLATION, WIRING AND START-UP. THE USER IS ALSO RESPONSIBLE FOR UNDERSTANDING AND APPLYING ALL OTHER APPLICABLE LOCAL CODES, WHICH GOVERN SUCH PRACTICES AS WIRING PROTECTION, GROUNDING, DISCONNECTS AND OVERCURRENT PROTECTION.



UNDER NO CIRCUMSTANCES SHOULD FIELD AC POWER BE APPLIED TO TB1 (FP1, FP2) IN THE ABSENCE OF CONTROL POWER. FIELD POWER SHOULD ALWAYS BE APPLIED AFTER CONTROL POWER HAS BEEN APPLIED AND HAS HAD SUFFICIENT TIME TO STABILIZE. THE CORRECT SEQUENCE FOR NORMAL OPERATION IS CONTROL POWER FIRST, FIELD POWER SECOND.



THE MACHINE SHOULD NEVER BE USED "IN SERVICE" WHILE ADJUSTING. THE SPEED MAY NOT BE ACCURATELY ADJUSTED AND THE TACHOMETER LOSS CIRCUIT MAY BE DISABLED. WHILE RUNNING THE CAR DURING ADJUSTMENT, KEEP A SAFE DISTANCE FROM THE TERMINAL LANDINGS, VISUALLY OBSERVING THE CAR AT ALL TIMES.

TACHOMETER (TACH- TACH+ TACH GND)

The control is capable of accepting a noise-free tachometer signal from 15 to 150 volts DC at full speed. The tachometer signal **must** be free of noise to get acceptable regulation due to the high gain of the control circuitry and the fast response of the control system. For best results, the tachometer should be coupled directly with the Hoist Motor shaft and properly aligned for minimal noise. Any misalignment will transmit noise to the tachometer, which in turn will be passed to the regulator, resulting in oscillation or rumbling in the elevator car in extreme cases. The tachometer cable should be shielded, with the shield terminated at the **TACHGND** terminal (**J2-3**).

Note: It is not advisable to use any material that is flexible, such as rubber or soft plastics when coupling the tachometer to the motor shaft. These materials tend to create a noise or oscillation problem in the car by introducing ripple on the tachometer signal.

REF IN (J3-1)

This input accepts the **SP1** through **SP4** and **HI** speed contacts. Refer to the hook-up diagram for recommended contact interlocking. The **REF IN** input at **J3-1** is also used to preset the speed potentiometers by monitoring with a DC voltmeter and closing the desired speed contact.

SPEED CONTACTS SP1 THROUGH SP4 AND HI (J3)

These contacts connect the corresponding speed input to the **REF IN** input of the control. **Contacts must be arranged to select only one speed input at a time.** Simultaneous selection of the speed contacts may overload the internal power supplies and give unpredictable results.

- SP1** = 0 to 15% of contract speed
- SP2** = 0 to 99% of contract speed
- SP3** = 0 to 99% of contract speed
- SP4** = 0 to 99% of contract speed
- HI** = 100% (Contract Speed) non-adjustable

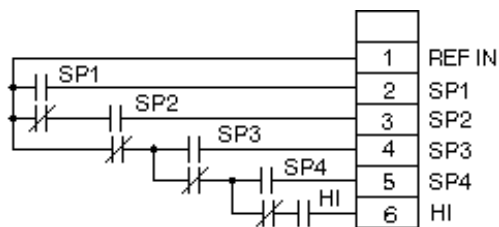

FIGURE FIVE

ACCEL/DECEL CONTACTS (ACC1, ACC2, DCC1, DCC2, DCC3)

These contacts determine which acceleration or deceleration rate the reference output will follow. The control will respond to the corresponding contact closed during acceleration or deceleration of the car to a set speed point. **Contacts must be arranged to select only one accel and one decel input at a time.** If only one accel or decel rate is required, relay contacts can be eliminated and appropriate jumpers added.

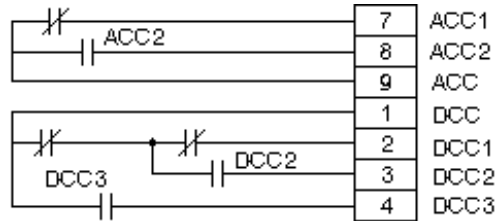

FIGURE SIX

CONTROL

The **CONTROL** terminal is the common point for the connections to the **UP**, **DOWN**, **RUN** and **RESET** selection contacts. The diagram below shows the suggested contact arrangement.

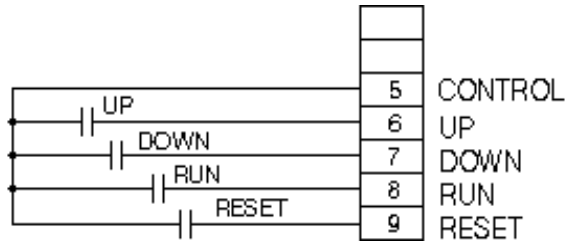

FIGURE SEVEN

UP/DOWN J4-6/7

Either the **UP** contact or the **DOWN** contact must be energized in order to call for a direction. The control will not be enabled if both UP and DOWN are energized.

RUN J4-8

The **RUN** contact must be energized in order to enable the control. When the RUN contact is opened, the control output will be disabled and the output semiconductors are prevented from turning on. If the RUN contact is energized and the UP and DOWN contacts are opened, the control will regulate zero speed. The RUN contact must be closed before the customer AC power relay is pulled in. **The RUN contact should be opened whenever the car is stopped or the doors are opened.**

RESET J4-9

The RESET input serves two purposes. If the RESET input is connected to the CONTROL terminal via a jumper, the control will be placed into an *auto reset* mode. When the control is in *auto reset* mode, if a trip condition occurs, removing the trip condition and dropping and re-applying the RUN contact will reset the control. If the RESET input is connected to the CONTROL terminal through a normally open contact, the control will be placed in a *manual reset* mode. When the control is in *manual reset* mode, if a trip condition occurs, the trip condition will remain until the RESET contact is closed and the RUN contact is opened.

REGULATOR PHYSICAL DIMENSIONS

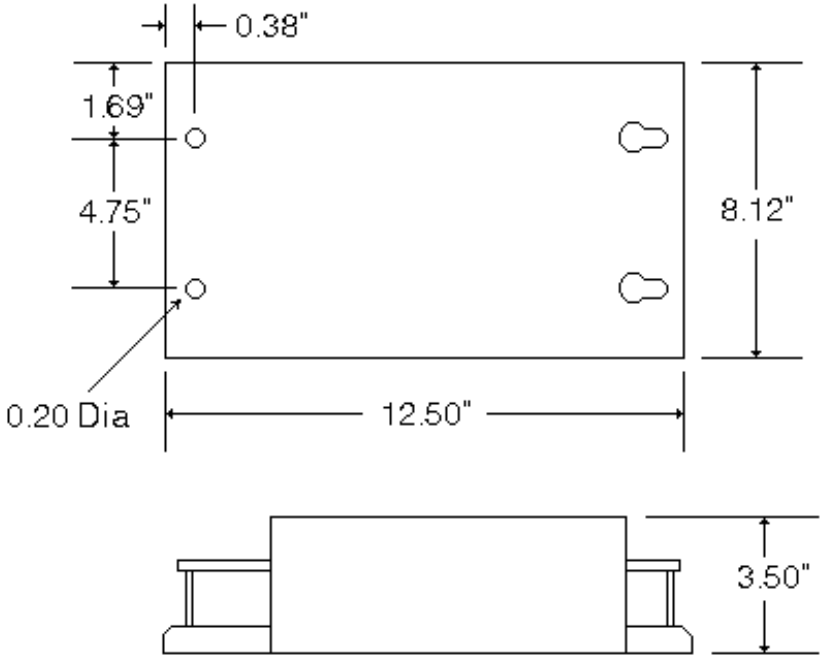

Length: 12.50 inches

Width: 8.12 inches

Height: 4.50 inches

FIGURE EIGHT

POWER CONNECTIONS

The following section describes the connections to be made in order to properly connect the control to the elevator system power connections. All of the connections are to be made to the appropriate terminals of TB1 located on the power (bottom) board.

ARMATURE INPUT (ARM-, ARM+)

The connections from the hoist motor armature to **ARM-** and **ARM+** should be externally fused using 5 Amp fuses for safety. It is important to ensure that the connections are properly polarized. Improper connections will cause faulty operation of the control.

ENABLE RELAY (EN-A, EN-C)

The enable relay provides a set of normally open contacts that will close when the control is operating properly. These contacts will open whenever a fault condition occurs. The enable contacts are rated for 250 VAC @ 5 A.

OVER VOLTAGE BUSS RESISTOR

A 50-Ohm, 250 Watt resistor (typically supplied by IPC) must be connected to the terminals marked **R+** and **R-** on TB1. This resistor protects the D1025MKII field power buss from over voltage conditions, which are caused by sudden power loss or an abrupt change in direction.



THE OVER VOLTAGE RESISTOR MUST BE INSTALLED AT ALL TIMES DURING OPERATION OF THE CONTROL, OTHERWISE, SEVERE DAMAGE TO THE CONTROL WILL OCCUR.

AC FIELD POWER INPUT (FP1-FP2)

The connections to the field power inputs are from the customer's AC field power relays. These relays are attached to the secondary taps on the field power isolation transformer (typically supplied by IPC). These connections supply the AC power for the output section of the D1025MKII. The maximum output voltage and current are determined by the secondary tap connections to the **FP1** and **FP2** terminals. These inputs are not phase sensitive.

FIELD OUTPUT (F+, F-)

Connect the positive side of the generator field to the **F+** terminal on TB1. Connect the negative side of the generator field to the **F-** terminal on TB1. If these connections are reversed the direction of the car will usually reverse. Damage to the control could possibly occur from an improper connection.

AC CONTROL POWER (L1, L2)

Apply 208/230 VAC to the **L1** and **L2** terminals of TB1. These inputs are not phase sensitive.

EXTERNAL POWER CONNECTIONS

CUSTOMER AC FIELD POWER RELAY

The D1025MKII utilizes a *Soft Start* feature that eliminates the need for high current contactors for the Customer Field Power Relay. A relay that is rated for 10 Amps continuous usage will be sufficient for the Field Power Relay. These contacts should make prior to running, and break after the **UP** or **DOWN** relays drop, the car stops, and the brake sets.

SERIES FIELD RESISTOR (R3)

It will be necessary to adjust the series field resistor **R3** to limit the field current. Resistor **R3** limits the maximum output voltage to the generator field. This value should be adjusted as necessary to make sure you can reach contract speed and to account for a drop in line voltage. The selection of the **R3** resistor will be covered in detail in Section Five.

RE-LEVELING RESISTOR (R1)

Re-level resistor **R1** (See hook-up drawing) is used to limit the field current during re-leveling. The value must be determined based on the requirements of the installation. The selection of the R1 resistor will be covered in detail in Section Five.

NOTE: The values of **R1** and **R3** are suggested values by IPC. The values of **R1** and **R3** can be calculated per project from the data provided by the motor generator and hoist motor manufacturer. The generator field control will produce a maximum output voltage of 156/223 VDC on a line of 208/230 VAC. **R1** should be inserted in re-leveling (or leveling, if desired) and sized to produce the desired re-leveling or leveling speed.

R1, R2, R3, and R4 are not provided by IPC.

SUICIDE CIRCUIT

The suicide circuit disconnects the generator field from the regulator and places the field across the armature. During the opening of the field (or run) contact, any field current flowing must continue to flow and the contacts will arc until the field current decays.

It is absolutely necessary that the arc is extinguished and the continuity of the field current to the regulator is open before the suicide contacts are closed. Any overlapping of these contacts will cause damage to the regulator. Therefore, the suicide contacts must be delayed 1 - 5 seconds in closing even under "power loss" conditions.

The time delay will depend on the duration of the arc across the field contacts. For this reason, we have shown resistors **R2** and **R4** across the field contacts to permit some current flow during the opening of the **RUN** contacts. **R2** and **R4** will provide a discharge path through the control for the field current, preventing damage to the regulator caused by the closing of the suicide contact. **Please reference hook-up diagram for recommended contact configuration and run/suicide sequence (delay).**

EMERGENCY RUN CIRCUIT (ER) "OPTIONAL"

If desired, an external DC generator field supply can be used to move the car at a fixed low speed. This arrangement is useful in the event of an emergency, or during the construction phase of an installation. It is also useful if there is a D1025 control malfunction. See hook-up diagram for **ER** contact configuration. The ER contacts and emergency power supply are NOT provided by IPC.

SECTION FIVE SET UP PROCEDURE



THE BI-DIRECTIONAL FIELD REGULATOR SHOULD BE INSTALLED, ADJUSTED AND SERVICED BY QUALIFIED ELECTRICAL MAINTENANCE PERSONNEL FAMILIAR WITH THE CONSTRUCTION AND OPERATION OF ALL EQUIPMENT IN THE ELEVATOR SYSTEM; PERSONAL INJURY AND/OR EQUIPMENT DAMAGE MAY OCCUR IF INDIVIDUALS ARE NOT FAMILIAR WITH THE HAZARDS RESULTING FROM IMPROPER OPERATION.



THE BI-DIRECTIONAL FIELD REGULATOR IS AT LINE VOLTAGE WHEN AC POWER IS CONNECTED AND INTERNAL CAPACITORS REMAIN CHARGED AFTER POWER IS REMOVED FROM THE UNIT. IT IS IMPORTANT THAT AC POWER IS REMOVED FROM THE UNIT FOR A MINIMUM OF FIVE MINUTES BEFORE TOUCHING THE INTERNAL PARTS OF THE CONTROL. PERSONAL INJURY MAY RESULT UNLESS POWER IS REMOVED AND TIME IS ALLOWED FOR DISCHARGE.



THE USER IS RESPONSIBLE FOR CONFORMING TO THE NATIONAL ELECTRICAL CODE WITH RESPECT TO MOTOR, CONTROLLER AND OPERATOR DEVICE INSTALLATION, WIRING AND START-UP. THE USER IS ALSO RESPONSIBLE FOR UNDERSTANDING AND APPLYING ALL OTHER APPLICABLE LOCAL CODES, WHICH GOVERN SUCH PRACTICES AS WIRING PROTECTION, GROUNDING, DISCONNECTS AND OVERCURRENT PROTECTION.



UNDER NO CIRCUMSTANCES SHOULD FIELD AC POWER BE APPLIED TO TB1 (FP1, FP2) IN THE ABSENCE OF CONTROL POWER. FIELD POWER SHOULD ALWAYS BE APPLIED AFTER CONTROL POWER HAS BEEN APPLIED AND HAS HAD SUFFICIENT TIME TO STABILIZE. THE CORRECT SEQUENCE FOR NORMAL OPERATION IS CONTROL POWER FIRST, FIELD POWER SECOND.



THE MACHINE SHOULD NEVER BE USED "IN SERVICE" WHILE ADJUSTING. THE SPEED MAY NOT BE ACCURATELY ADJUSTED AND THE TACHOMETER LOSS CIRCUIT MAY BE DISABLED. WHILE RUNNING THE CAR DURING ADJUSTMENT, KEEP A SAFE DISTANCE FROM THE TERMINAL LANDINGS, VISUALLY OBSERVING THE CAR AT ALL TIMES.

PRELIMINARY SET UP: (*MG SET NOT RUNNING*)

In this section, an estimate of the armature voltage and the output voltage of the regulator will be calculated for several speeds. This will help to ensure a proper set up and calibration of the regulator.

- 5.1.1.** Measure the generator field resistance attached to **F+** and **F-**. Check the fields for grounds with a Megger or other instrument for this purpose. No grounds should occur in the field circuit.

Write measured resistance of the generator field here _____ (ohms).

- 5.1.2.** Use the table below to select the appropriate transformer secondary tap. Select the lowest AC tap available for the resistance you measured.

GENERATOR FIELD RESISTANCE	TRANSFORMER SECONDARY TAP	MAXIMUM DC FIELD VOLTAGE AVAILABLE
20 To 150 Ohms	X1 To X2 110 Volts AC	156 Volts DC
25 To 162 Ohms	X1 To X3 130 Volts AC	184 Volts DC
28 To 210 Ohms	X1 To X4 150 Volts AC	212 Volts DC
30 To 250 Ohms	X1 To X5 165 Volts AC	233 Volts DC

TABLE TWO

- 5.1.3.** Change your selection only if you know that the DC field voltage available is not enough to reach contract speed.

A. Write transformer tap you selected here: _____.

B. Write the maximum DC field voltage available here: _____ VDC

- 5.1.4.** Table Three displays the relationship between the voltage at the REF OUT testpoint in relation to the ARM FEEDBACK voltage and the speed of the car.

CONTRACT SPEED IN FEET PER MINUTE

% Of Contract Speed	250	300	350	400	450	500	550	600	700	800	Speed Setting (Volts)	Arm FB Setting (Volts)
5.00%	13	15	18	20	23	25	28	30	35	40	0.50	0.38
10.00%	25	30	35	40	45	50	55	60	70	80	1.00	0.75
15.00%	38	45	53	60	68	75	83	90	105	120	1.50	1.13
20.00%	50	60	70	80	90	100	110	120	140	160	2.00	1.50
25.00%	63	75	88	100	113	125	138	150	175	200	2.50	1.88
30.00%	75	90	105	120	135	150	165	180	210	240	3.00	2.25
35.00%	88	105	122	140	158	175	193	210	245	280	3.50	2.63
40.00%	100	120	140	160	180	200	220	240	280	320	4.00	3.00
45.00%	113	135	158	180	203	225	248	270	315	360	4.50	3.38
50.00%	125	150	175	200	225	250	275	300	350	400	5.00	3.75
55.00%	138	165	193	220	248	275	303	330	385	440	5.50	4.13
60.00%	150	180	210	240	270	300	330	360	420	480	6.00	4.50
65.00%	163	195	228	260	293	325	358	390	455	520	6.50	4.88
70.00%	175	210	245	280	315	350	385	420	490	560	7.00	5.25
75.00%	188	225	263	300	338	375	413	450	525	600	7.50	5.63
80.00%	200	240	280	320	360	400	440	480	560	640	8.00	6.00
85.00%	213	255	298	340	383	425	468	510	595	680	8.50	6.38
90.00%	225	270	315	360	405	450	495	540	630	720	9.00	6.75
95.00%	238	285	333	380	428	475	523	570	665	760	9.50	7.13
100.00%	250	300	350	400	450	500	550	600	700	800	10.00	7.50

TABLE THREE

Table Three will now be used to help determine the various voltage settings you will need to setup the control for your elevator.

A. Write the contract speed here: _____ **FPM.**

B. Write the inspection speed here: _____ **FPM.**

Find your contract speed in the first row of table three. Now read down the column that you just located until you find your inspection speed. Now read across the row to the right to the first shaded column. This is the speed reference voltage that you will need to see at the **REF OUT** testpoint during an inspection speed run. The **SP3** pot is typically used for inspection speed. This is the voltage setting that you will adjust the **SP3** pot for.

C. Write the REF OUT voltage here: _____ **VDC.**

Now read the rightmost shaded column. This is the Armature Feedback voltage setting.

D. Write the armature feedback voltage here: _____ **VDC.**

Now read across the row, which contains the inspection speed to the leftmost shaded column. This is the percentage of the contract speed or inspection speed percentage.

E. Write the inspection speed percentage here: _____ **%.**

5.1.5. Now locate any other speeds you may require for your application by reading up and down the same contract speed column and then reading across to the shaded columns to determine the corresponding speed reference voltage.

A. Write the elevator speed for SP1 here: _____ **FPM**

B. Write the speed reference voltage for SP1 here: _____ **VDC**

C. Write the elevator speed for SP2 here _____ **FPM**

D. Write the speed reference voltage for SP2 here: _____ **VDC**

E. Write the elevator speed for SP4 here: _____ **FPM**

F. Write the speed reference voltage for SP4 here: _____ **VDC**

5.1.6. Find the resistance value of the field (measured in step 1) in the first column of Table Four
Read across to the column with the transformer tap you selected in step 5.1.3 to determine
the estimated field current required for contract speed.

Write estimated field current here _____AMPS.

ESTIMATED FIELD CURRENT (AMPS)

FIELD RESISTANCE IN OHMS	X1 TO X2 110 VAC	X1 TO X3 130 VAC	X1 TO X4 150 VAC	X1 TO X5 165 VAC
20	7.78	×	×	×
23	6.76	7.99	×	×
25	6.22	7.35	×	×
28	5.56	6.57	7.58	×
30	5.18	6.13	7.07	7.78
40	3.89	4.60	5.30	5.83
50	3.11	3.68	4.24	4.67
80	1.94	2.30	2.65	2.92
100	1.56	1.84	2.12	2.33
125	1.24	1.47	1.70	1.87
150	1.04	1.23	1.41	1.56
175	0.89	1.05	1.21	1.33
200	0.78	0.92	1.06	1.17
225	0.69	0.82	0.94	1.04

TABLE FOUR

YOU ARE NOW READY TO BEGIN SET UP

SET UP: (MG SET NOT RUNNING)

The following section will adjust the D1025 MKII to the settings determined in the previous section.

- 5.2.1. Connect the regulator to system. Typical connections are shown in the hook-up print. See warnings on page one.
- 5.2.2. Put the J8 jumper in the **SET UP** position; with the **MG set stopped**. See section 3.8 for information about the Auto/Set Up jumper.
- 5.2.2. Turn all potentiometers on the front panel fully counter clockwise for minimum settings. Turn all S-Curve potentiometers full clockwise to sharp.
- 5.2.3. Attach the positive lead of a digital voltmeter to the **REF IN** terminal J3-1. Attach the negative lead of the voltmeter to the **COMMON** testpoint.
- 5.2.4. Apply power to the control. **Note:** The RUN contact at J3-8 does not have to be closed.
- 5.2.5. Close the **SP1** contact. Adjust the **SP1** potentiometer until you measure the voltage value you selected in step **5.1.5 B**.
- 5.2.6. Open the **SP1** contact and close the **SP2** contact. Adjust the **SP2** potentiometer until you measure the voltage value you selected in step **5.1.5 D**.
- 5.2.7. Open the **SP2** contact and close the **SP4** contact. Adjust the **SP4** potentiometer until you measure the voltage value you selected in step **5.1.5 F**.
- 5.2.8. Open the **SP4** contact and close the **SP3** contact. Adjust the inspection speed pot (**SP3**) until you measure the voltage value you selected in step **5.1.4 C**.
- 5.2.9. Turn the **CONTRACT SPD** potentiometer two turns clockwise to mid range. Turn the **ARM FEEDBACK** potentiometer two turns clockwise to mid range.
- 5.2.10. Turn the tachometer by hand in the direction that the tachometer will rotate while the car is traveling in the UP direction. Note the polarity of the tachometer signal.
- 5.2.11. Connect the positive lead of the tachometer to the **TACH+** terminal J2-2. Connect the negative lead of the tachometer to the **TACH-** terminal J2-1. Connect the shield of the tachometer cable to the **GND** terminal J2-3.

Note: The shield of the tachometer cable should be connected to the D1025 MKII only. Do **not** connect the shield at the tachometer side.

SET-UP (MG SET RUNNING)

The following steps are to be performed with the elevator car in the middle of the shaft way. The D1025 MKII should be in **SET UP** mode (**AUTO/SET UP** jumper in the **SET UP** position). The TACH LOSS (J7) and SPEED FAULT (J10) jumpers should be shorted to disable their respective trip circuits. The Motor Generator set should be running and the car should be prepared to call for a run at inspection speed.

The proper sequencing of contact closure is essential for proper operation of the D1025 MKII. The following sequence is recommended:

1. AC control power is applied to the D1025 MKII.
2. The **RUN** contact is closed at J4-8 of the D1025 MKII. Customer RUN contacts may also close at this time.
3. Customer's AC field power contacts are closed, applying secondary voltage from the isolation transformer to the D1025 MKII **FP1** and **FP2** Field Power terminals.
4. Call for a direction by closing the **UP** contact at J3-6 of the D1025 MKII.
5. Call for a speed by closing speed contact **SP3** at J3-4 of the D1025 MKII.



THE FOLLOWING STEPS SHOULD BE PERFORMED IN THE SET UP MODE. (AUTO/SET UP JUMPER IN THE SET UP POSITION) DO NOT ATTEMPT THIS PROCEDURE IN THE NORMAL RUNNING (AUTO) MODE.

- 5.3.1. Call for a run at inspection speed in the **UP** direction.
- 5.3.2. Determine the actual speed of the car with a hand-held tachometer.
- 5.3.3. Call for a run at inspection speed. Monitor the tachometer feedback voltage by placing the positive lead of a multimeter on the **TACH FDBK** testpoint and the negative lead of the multimeter on the **COMMON** testpoint. Adjust the **CONTRACT SPD** potentiometer until the voltage is equal to the voltage at the **REF OUT** testpoint.

Note: **If the TACH FDBK testpoint is equal to 10 volts, you must turn the CONTRACT SPD pot counterclockwise until the TACH FDBK testpoint is equal to the REF OUT testpoint. ELEVATOR SPEED IS NOT BEING REGULATED AT THIS TIME AND WILL NOT CHANGE.**

- 5.3.4. Move the positive lead of the multimeter to the **ARM FDBK** testpoint. Call for a run in the **UP** direction at inspection speed. *The voltage at the ARM FB testpoint must be positive.* If the voltage is negative, you must reverse the leads to **ARM+** and **ARM-** on TB1.

- 5.3.5.** Adjust the **ARM FBK** potentiometer until the voltage is equal to the voltage value selected in step **5.1.4 D**. This voltage should be equal to the voltage at the **REF IN** terminal (J3-1) multiplied by 0.75.

NORMAL RUNNING MODE

In this section, the D1025 MKII will be put into the **AUTO** mode. The tachometer feedback and armature feedback voltages will be fine-tuned to achieve complete closed loop operation. The following steps require the use of a dual trace storage oscilloscope for maximum precision. It is suggested that you leave the TACH LOSS (J7) and SPEED FAULT (J10) jumpers shorted until this procedure is completed.

- 5.4.1.** Open the customer RUN contacts. Open the customer AC Field Power contacts. Open the **RUN** contact at J4-8 on the D1025 MKII. Turn off the control AC power and put the **AUTO/SET UP** jumper in the **AUTO** position.
- 5.4.2.** Turn the **LOOP GAIN** potentiometer two turns clockwise to the center position.
- 5.4.4.** Set up the oscilloscope as follows:
- Connect scope gnd (floating) to the **COMMON** test point (TP5).
 - Connect the Channel 1 probe to the **REF OUT** test point (TP1).
 - Connect Channel 2 probe to the **TACH FDBK** test point (TP2).
 - Set the Volts/Division to 2V/division for both Channel 1 and Channel 2.
 - Set the Time base to 0.1 sec/div.
 - Set the display mode to Dual Trace (Ch1 & Ch2).
 - Set the Storage mode to roll.
 - Set both traces at one division above bottom graticule.

CURRENT AND CONTRACT SPEED CALIBRATION

- 5.4.5.** Call for a run at low speed (ie. **SP1**) in the **UP** direction. Observe the **REF OUT** and **TACH FDBK** signals on the oscilloscope. Both should be positive for the **UP** direction.
- 5.4.6.** Call for a run at low speed in the **DN** direction. Observe the **REF OUT** and **TACH FDBK** signals on the oscilloscope. Both signals should be negative and of the same magnitude as in step 5.4.5.
- 5.4.7.** Call for a run at inspection speed (ie. **SP3**) in the **UP** direction.
- A.** Monitor the **TACH FDBK** testpoint (TP2) with a voltmeter.

- B.** Adjust the **CONTRACT SPEED** potentiometer until the signal at the **TACH FDBK** testpoint (TP2) is equal to the signal at the **REF OUT** testpoint (TP1).

5.4.8. Call for a run at HI speed.

- A.** Using a hand-held tachometer, measure the actual HI speed on the sheave. The voltage at the **TACH FDBK** testpoint should be equal to 10 volts +/- 0.2 volts and the car should be running at contract speed.
- B.** Readjust the **CONTRACT SPD** potentiometer to obtain the exact contract speed equal to 10V at the **TACH FDBK** testpoint, if necessary.
- C.** Check the **ARM FDBK** testpoint (TP3) and verify that the voltage reading is 7.5V at contract speed.
- D.** Make a few long runs in both the UP and DN directions. Observe the oscilloscope and adjust the acceleration and deceleration rates and transitional knees of the S-Curve as required.

- 5.4.9.** The following oscilloscope plots show the **TACH FDBK** (channel 2) and **REF OUT** (channel 1) testpoint signals. An ideal trace occurs when the tachometer and the reference signals track on top of each other over the entire run.

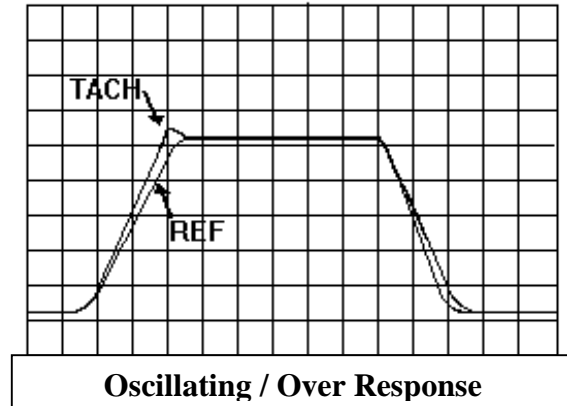
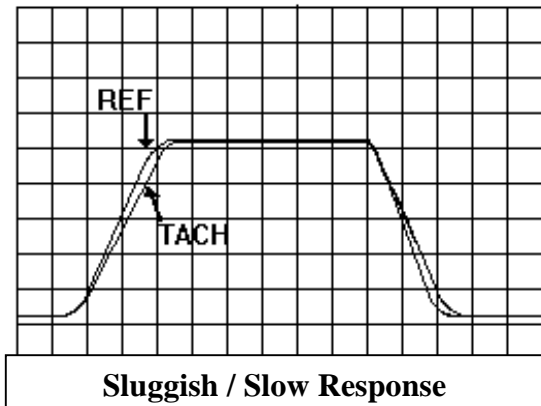
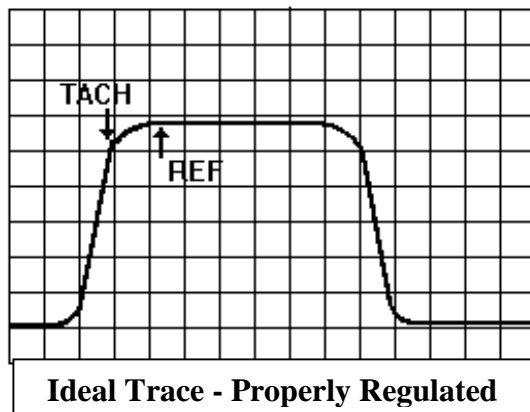

FINE TUNING ADJUSTMENTS

Fine tuning the performance of the D1025 MKII requires a good deal of trial and error. The following suggestions are to be used only as a guide. There are often many combinations of acceleration and deceleration settings as well as **LOOP GAIN**, **ARM FEEDBACK**, and **STABILITY** settings that will produce a properly regulated **TACH FDBK** vs. **REF OUT** pattern.

SLUGGISH RESPONSE

The **TACH FDBK** signal is lagging far behind the **REF OUT** signal. This is causing an **OUT OF REG** (out of regulation) condition. The elevator is slow reaching top speed and may take too long to reach the floor during deceleration.

TUNING PROCEDURE FOR SLUGGISH/SLOW RESPONSE:

1. Check and adjust the acceleration and deceleration rates because they may be too long.
2. Increase the **LOOP GAIN** potentiometer clockwise as required, observing the pattern.
3. If the **LOOP GAIN** potentiometer is full clockwise and the response is still sluggish reset the **LOOP GAIN** potentiometer to the center position.
4. Monitor the **ARM FDBK** testpoint (TP3) with a voltmeter.
5. Decrease the **ARM FEEDBACK** potentiometer by turning the pot counterclockwise slightly ($\frac{1}{2}$ volt on the **ARM FDBK** testpoint), observing the pattern.
6. Increase the **STABILITY** potentiometer clockwise if the pattern becomes unstable.
7. Repeat steps 4 through 6 as required.



AN ARMATURE FEEDBACK SETTING BELOW $\pm 4.0V$ AT CONTRACT SPEED CAN CAUSE THE TACH LOSS CIRCUIT TO BE INOPERATIVE DO NOT SET THE ARMATURE FEEDBACK TESTPOINT BELOW $\pm 4.0V$ AT CONTRACT SPEED.

OVERSHOOT/INSTABILITY

In this case the **TACH FDBK** signal is often leading the **REF OUT** signal or oscillating around it. The control is correcting too quickly for changes causing the elevator to be unstable.

TUNING PROCEDURE FOR OSCILLATING/OVER RESPONSE

1. Check and adjust the acceleration rates because they may be too short.
2. Decrease the **LOOP GAIN** potentiometer counterclockwise as required, observing the pattern.
3. If the **LOOP GAIN** potentiometer is fully counterclockwise and the response is still too fast, reset the **LOOP GAIN** potentiometer to the center position.
4. Increase the **STABILITY** potentiometer clockwise, observing the pattern.
5. If the **STABILITY** potentiometer is fully clockwise and the response is still unstable reset the **STABILITY** potentiometer fully counterclockwise.
6. Monitor the **ARM FEEDBACK** testpoint with a voltmeter.
7. Increase the **ARM FEEDBACK** potentiometer clockwise slightly, ($\frac{1}{2}$ volt on the **ARM FEEDBACK** testpoint), observing the pattern.
8. Increase the **STABILITY** potentiometer clockwise if the pattern becomes unstable.
9. Repeat steps 4 through 8 as required.



THE ARM FDBK TESTPOINT SHOULD NEVER BE GREATER THAN ± 10 VOLTS AT CONTRACT SPEED.

ZERO SPEED REGULATION

The D1025 MKII has the ability to regulate zero speed. This is accomplished by dropping the UP and DN contacts while holding the RUN contact at J4-8 energized. As long as the RUN contact at J4-8 is closed, the D1025 MKII will produce a zero speed output. If there is any creeping while regulating zero speed, you must remove the cover of the MKII and adjust the TACH NULL pot P20 until the creeping stops.

STOP DELAY

The ability to regulate zero speed when coupled with the **STOP DELAY** adjustment will enable you to fine-tune the ride of the car during the critical time when the car has reached the landing zone and the brake must be set. The **STOP DELAY** potentiometer is active when both the **UP** and **DN** or the **RUN** contacts are opened. When this occurs, the **REF OUT** and **TACH FDBK** signals will continue to follow the decel ramp for a period of time based on the setting of the **STOP DELAY** potentiometer. When the pot is fully counterclockwise, the **REF OUT** and **TACH FDBK** signals will continue to follow the decel ramp for 0.5 seconds. If the potentiometer is turned fully clockwise, the delay will be reduced to zero (0) seconds.

SELECTING A HIGH SPEED CURRENT LIMITING RESISTOR

The maximum speed of the elevator is dependent on the amount of current available to the generator field. By limiting the amount of current available to the generator field, we can limit the maximum speed of the elevator. There are two methods of limiting the maximum current available. The first method is to select a tap of the Field Power Isolation Transformer (typically supplied by IPC) which supplies just enough voltage to the field and allows the car to attain contract speed in a worst case high speed run (empty car down or full car up). The second method is necessary when you must move to a higher tap on the transformer and now have more than enough voltage/current available and can exceed the contract speed in a worst case high speed run. When this is the case, you must insert a resistor in series with the generator field to limit the maximum current available.

The following pages contain tables, which will be used to determine the value of the **HIGH SPEED CURRENT LIMITING RESISTOR** you must use to safely limit the current. In order to use the tables you will need to know the following:

- A. The Field Power Isolation Transformer secondary tap selected in step 5.1.3 A.
- B. The Generator Field Current at contract speed. This may be determined by placing the positive lead of a voltmeter on the **FIELD CURRENT** testpoint and measuring the voltage during a worst case high speed run. The field current is equal to the voltage measured at the testpoint (1V = 1A).
- C. The Maximum DC Field Voltage at contract speed. This may be measured at the **F+** and **F-** terminals during a worst case high speed run.

After you have selected the proper table, read down the left-hand column and find your field current at contract speed. Next, read across to the column that indicates your field voltage at contract speed. The value listed at the cell you just located is the resistance for the **HIGH-SPEED CURRENT LIMITING RESISTOR (R3)** (See Figure 1). This value should be adjusted as necessary to make sure you still reach contract speed and to account for a drop in line voltage.

If your transformer tap is **X1 to X2** **USE TABLE FIVE**

If your transformer tap is **X1 to X3** **USE TABLE SIX**

If your transformer tap is **X1 to X4** **USE TABLE SEVEN**

If your transformer tap is **X1 to X5** **USE TABLE EIGHT**

**DETERMINE THE VALUE OF THE HIGH SPEED CURRENT LIMITING RESISTOR
ISOLATION TRANSFORMER TAPS X1 TO X2 (110 VAC)**

FIELD VOLTAGE AT CONTRACT SPEED (Volts DC)

FIELD I(Amps)	100	105	110	115	120	125	130	135	140	145	150
1.00	55.54	50.54	45.54	40.54	35.54	30.54	25.54	20.54	15.54	10.54	5.54
1.25	44.43	40.43	36.43	32.43	28.43	24.43	20.43	16.43	12.43	8.43	4.43
1.50	37.03	33.69	30.36	27.03	23.69	20.36	17.03	13.69	10.36	7.03	3.69
1.75	31.74	28.88	26.02	23.17	20.31	17.45	14.59	11.74	8.88	6.02	3.17
2.00	27.77	25.27	22.77	20.27	17.77	15.27	12.77	10.27	7.77	5.27	2.77
2.25	24.68	22.46	20.24	18.02	15.80	13.57	11.35	9.13	6.91	4.68	2.46
2.50	22.22	20.22	18.22	16.22	14.22	12.22	10.22	8.22	6.22	4.22	2.22
2.75	20.20	18.38	16.56	14.74	12.92	11.11	9.29	7.47	5.65	3.83	2.01
3.00	18.51	16.85	15.18	13.51	11.85	10.18	8.51	6.85	5.18	3.51	1.85
3.25	17.09	15.55	14.01	12.47	10.94	9.40	7.86	6.32	4.78	3.24	1.70
3.50	15.87	14.44	13.01	11.58	10.15	8.73	7.30	5.87	4.44	3.01	1.58
3.75	14.81	13.48	12.14	10.81	9.48	8.14	6.81	5.48	4.14	2.81	1.48
4.00	13.89	12.64	11.39	10.14	8.89	7.64	6.39	5.14	3.89	2.64	1.39
4.25	13.07	11.89	10.72	9.54	8.36	7.19	6.01	4.83	3.66	2.48	1.30
4.50	12.34	11.23	10.12	9.01	7.90	6.79	5.68	4.56	3.45	2.34	1.23
4.75	11.69	10.64	9.59	8.53	7.48	6.43	5.38	4.32	3.27	2.22	1.17
5.00	11.11	10.11	9.11	8.11	7.11	6.11	5.11	4.11	3.11	2.11	1.11
5.25	10.58	9.63	8.67	7.72	6.77	5.82	4.86	3.91	2.96	2.01	1.06
5.50	10.10	9.19	8.28	7.37	6.46	5.55	4.64	3.73	2.83	1.92	1.01
5.75	9.66	8.79	7.92	7.05	6.18	5.31	4.44	3.57	2.70	1.83	0.96
6.00	9.26	8.42	7.59	6.76	5.92	5.09	4.26	3.42	2.59	1.76	0.92
6.25	8.89	8.09	7.29	6.49	5.69	4.89	4.09	3.29	2.49	1.69	0.89
6.50	8.54	7.78	7.01	6.24	5.47	4.70	3.93	3.16	2.39	1.62	0.85
6.75	8.23	7.49	6.75	6.01	5.27	4.52	3.78	3.04	2.30	1.56	0.82
7.00	7.93	7.22	6.51	5.79	5.08	4.36	3.65	2.93	2.22	1.51	0.79
7.25	7.66	6.97	6.28	5.59	4.90	4.21	3.52	2.83	2.14	1.45	0.76
7.50	7.41	6.74	6.07	5.41	4.74	4.07	3.41	2.74	2.07	1.41	0.74

**DETERMINE THE VALUE OF THE HIGH SPEED CURRENT LIMITING RESISTOR
ISOLATION TRANSFORMER TAPS X1 TO X3 (130 VAC)**

FIELD VOLTAGE AT CONTRACT SPEED (Volts DC)

FIELD I(Amps)	130	135	140	145	150	155	160	165	170	175	180
1.00	53.82	48.82	43.82	38.82	33.82	28.82	23.82	18.82	13.82	8.82	3.82
1.25	43.06	39.06	35.06	31.06	27.06	23.06	19.06	15.06	11.06	7.06	3.06
1.50	35.88	32.55	29.21	25.88	22.55	19.21	15.88	12.55	9.21	5.88	2.55
1.75	30.75	27.90	25.04	22.18	19.33	16.47	13.61	10.75	7.90	5.04	2.18
2.00	26.91	24.41	21.91	19.41	16.91	14.41	11.91	9.41	6.91	4.41	1.91
2.25	23.92	21.70	19.48	17.25	15.03	12.81	10.59	8.36	6.14	3.92	1.70
2.50	21.53	19.53	17.53	15.53	13.53	11.53	9.53	7.53	5.53	3.53	1.53
2.75	19.57	17.75	15.93	14.12	12.30	10.48	8.66	6.84	5.03	3.21	1.39
3.00	17.94	16.27	14.61	12.94	11.27	9.61	7.94	6.27	4.61	2.94	1.27
3.25	16.56	15.02	13.48	11.94	10.41	8.87	7.33	5.79	4.25	2.71	1.18
3.50	15.38	13.95	12.52	11.09	9.66	8.23	6.81	5.38	3.95	2.52	1.09
3.75	14.35	13.02	11.69	10.35	9.02	7.69	6.35	5.02	3.69	2.35	1.02
4.00	13.46	12.21	10.96	9.71	8.46	7.21	5.96	4.71	3.46	2.21	0.96
4.25	12.66	11.49	10.31	9.13	7.96	6.78	5.60	4.43	3.25	2.08	0.90
4.50	11.96	10.85	9.74	8.63	7.52	6.40	5.29	4.18	3.07	1.96	0.85
4.75	11.33	10.28	9.23	8.17	7.12	6.07	5.01	3.96	2.91	1.86	0.80
5.00	10.76	9.76	8.76	7.76	6.76	5.76	4.76	3.76	2.76	1.76	0.76
5.25	10.25	9.30	8.35	7.39	6.44	5.49	4.54	3.58	2.63	1.68	0.73
5.50	9.79	8.88	7.97	7.06	6.15	5.24	4.33	3.42	2.51	1.60	0.69
5.75	9.36	8.49	7.62	6.75	5.88	5.01	4.14	3.27	2.40	1.53	0.66
6.00	8.97	8.14	7.30	6.47	5.64	4.80	3.97	3.14	2.30	1.47	0.64
6.25	8.61	7.81	7.01	6.21	5.41	4.61	3.81	3.01	2.21	1.41	0.61
6.50	8.28	7.51	6.74	5.97	5.20	4.43	3.66	2.90	2.13	1.36	0.59
6.75	7.97	7.23	6.49	5.75	5.01	4.27	3.53	2.79	2.05	1.31	0.57
7.00	7.69	6.97	6.26	5.55	4.83	4.12	3.40	2.69	1.97	1.26	0.55
7.25	7.42	6.73	6.04	5.35	4.66	3.98	3.29	2.60	1.91	1.22	0.53
7.50	7.18	6.51	5.84	5.18	4.51	3.84	3.18	2.51	1.84	1.18	0.51

**DETERMINE THE VALUE OF THE HIGH SPEED CURRENT LIMITING RESISTOR
ISOLATION TRANSFORMER TAPS X1 TO X4 (150 VAC)**

FIELD VOLTAGE AT CONTRACT SPEED (Volts DC)

FIELD I (Amps)	160	165	170	175	180	185	190	195	200	205	210
1.00	52.10	47.10	42.10	37.10	32.10	27.10	22.10	17.10	12.10	7.10	2.10
1.25	41.68	37.68	33.68	29.68	25.68	21.68	17.68	13.68	9.68	5.68	1.68
1.50	34.73	31.40	28.07	24.73	21.40	18.07	14.73	11.40	8.07	4.73	1.40
1.75	29.77	26.91	24.06	21.20	18.34	15.49	12.63	9.77	6.91	4.06	1.20
2.00	26.05	23.55	21.05	18.55	16.05	13.55	11.05	8.55	6.05	3.55	1.05
2.25	23.16	20.93	18.71	16.49	14.27	12.04	9.82	7.60	5.38	3.16	0.93
2.50	20.84	18.84	16.84	14.84	12.84	10.84	8.84	6.84	4.84	2.84	0.84
2.75	18.95	17.13	15.31	13.49	11.67	9.85	8.04	6.22	4.40	2.58	0.76
3.00	17.37	15.70	14.03	12.37	10.70	9.03	7.37	5.70	4.03	2.37	0.70
3.25	16.03	14.49	12.95	11.42	9.88	8.34	6.80	5.26	3.72	2.18	0.65
3.50	14.89	13.46	12.03	10.60	9.17	7.74	6.31	4.89	3.46	2.03	0.60
3.75	13.89	12.56	11.23	9.89	8.56	7.23	5.89	4.56	3.23	1.89	0.56
4.00	13.03	11.78	10.53	9.28	8.03	6.78	5.53	4.28	3.03	1.78	0.53
4.25	12.26	11.08	9.91	8.73	7.55	6.38	5.20	4.02	2.85	1.67	0.49
4.50	11.58	10.47	9.36	8.24	7.13	6.02	4.91	3.80	2.69	1.58	0.47
4.75	10.97	9.92	8.86	7.81	6.76	5.71	4.65	3.60	2.55	1.49	0.44
5.00	10.42	9.42	8.42	7.42	6.42	5.42	4.42	3.42	2.42	1.42	0.42
5.25	9.92	8.97	8.02	7.07	6.11	5.16	4.21	3.26	2.30	1.35	0.40
5.50	9.47	8.56	7.65	6.75	5.84	4.93	4.02	3.11	2.20	1.29	0.38
5.75	9.06	8.19	7.32	6.45	5.58	4.71	3.84	2.97	2.10	1.23	0.37
6.00	8.68	7.85	7.02	6.18	5.35	4.52	3.68	2.85	2.02	1.18	0.35
6.25	8.34	7.54	6.74	5.94	5.14	4.34	3.54	2.74	1.94	1.14	0.34
6.50	8.02	7.25	6.48	5.71	4.94	4.17	3.40	2.63	1.86	1.09	0.32
6.75	7.72	6.98	6.24	5.50	4.76	4.01	3.27	2.53	1.79	1.05	0.31
7.00	7.44	6.73	6.01	5.30	4.59	3.87	3.16	2.44	1.73	1.01	0.30
7.25	7.19	6.50	5.81	5.12	4.43	3.74	3.05	2.36	1.67	0.98	0.29
7.50	6.95	6.28	5.61	4.95	4.28	3.61	2.95	2.28	1.61	0.95	0.28

**DETERMINE THE VALUE OF THE HIGH SPEED CURRENT LIMITING RESISTOR
ISOLATION TRANSFORMER TAPS X1 TO X5 (165 VAC)**

FIELD VOLTAGE AT CONTRACT SPEED (Volts DC)

FIELD (Amps)	190	195	200	205	210	215	220	225	230
1.00	43.31	38.31	33.31	28.31	23.31	18.31	13.31	8.31	3.31
1.25	190.00	30.65	26.65	22.65	18.65	14.65	10.65	6.65	2.65
1.50	43.31	25.54	22.21	18.87	15.54	12.21	8.87	5.54	2.21
1.75	190.00	21.89	19.03	16.18	13.32	10.46	7.61	4.75	1.89
2.00	43.31	19.16	16.66	14.16	11.66	9.16	6.66	4.16	1.66
2.25	190.00	17.03	14.80	12.58	10.36	8.14	5.92	3.69	1.47
2.50	43.31	15.32	13.32	11.32	9.32	7.32	5.32	3.32	1.32
2.75	190.00	13.93	12.11	10.29	8.48	6.66	4.84	3.02	1.20
3.00	43.31	12.77	11.10	9.44	7.77	6.10	4.44	2.77	1.10
3.25	190.00	11.79	10.25	8.71	7.17	5.63	4.10	2.56	1.02
3.50	43.31	10.95	9.52	8.09	6.66	5.23	3.80	2.37	0.95
3.75	190.00	10.22	8.88	7.55	6.22	4.88	3.55	2.22	0.88
4.00	43.31	9.58	8.33	7.08	5.83	4.58	3.33	2.08	0.83
4.25	190.00	9.01	7.84	6.66	5.48	4.31	3.13	1.96	0.78
4.50	43.31	8.51	7.40	6.29	5.18	4.07	2.96	1.85	0.74
4.75	190.00	8.07	7.01	5.96	4.91	3.85	2.80	1.75	0.70
5.00	43.31	7.66	6.66	5.66	4.66	3.66	2.66	1.66	0.66
5.25	190.00	7.30	6.34	5.39	4.44	3.49	2.54	1.58	0.63
5.50	43.31	6.97	6.06	5.15	4.24	3.33	2.42	1.51	0.60
5.75	190.00	6.66	5.79	4.92	4.05	3.18	2.31	1.45	0.58
6.00	43.31	6.39	5.55	4.72	3.89	3.05	2.22	1.39	0.55
6.25	190.00	6.13	5.33	4.53	3.73	2.93	2.13	1.33	0.53
6.50	43.31	5.89	5.12	4.36	3.59	2.82	2.05	1.28	0.51
6.75	190.00	5.68	4.93	4.19	3.45	2.71	1.97	1.23	0.49
7.00	43.31	5.47	4.76	4.04	3.33	2.62	1.90	1.19	0.47
7.25	190.00	5.28	4.59	3.90	3.22	2.53	1.84	1.15	0.46
7.50	43.31	5.11	4.44	3.77	3.11	2.44	1.77	1.11	0.44

SELECTING A LEVELING/RE-LEVELING CURRENT LIMITING RESISTOR

A LEVELING/RE-LEVELING CURRENT LIMITING RESISTOR is absolutely necessary to ensure safe performance of the elevator. The purpose of this resistor is to limit the maximum speed that the elevator could reach while leveling/re-leveling if the control was to fail in a fully on state. This resistor is labeled **R1** on the hook-up print. ***Without a LEVELING/RE-LEVELING CURRENT LIMITING RESISTOR, If the D1025 MKII was to fail fully on, the elevator car would take-off and run at full (contract) speed.***

The following pages contain tables which will be used to determine the value of the **LEVELING/RE-LEVELING CURRENT LIMITING RESISTOR** you must use to safely limit the current. In order to use the tables you will need to know the following:

- A. The Field Power Isolation Transformer secondary tap selected in step 5.1.3 A.
- B. The Generator Field Current at leveling/re-leveling speed. This may be determined by placing the positive lead of a voltmeter on the **FIELD CURRENT** testpoint and measuring the voltage for a worst case run during leveling. The field current is equal to the voltage measured at the testpoint ($1V = 0.75A$).
- C. The Maximum DC Field Voltage at leveling speed. This may be measured at the **F+** and **F-** terminals during a worst case leveling speed run.

After you have selected the proper table, read down the left-hand column and find your field current at contract speed. Next, read across to the column that indicates your field voltage at contract speed. The value listed at the cell you just located is the resistance for the **LEVELING/RE-LEVELING CURRENT LIMITING RESISTOR (R1)**. This value should be adjusted as necessary to make sure you still reach leveling speed and to account for a drop in line voltage.

If your transformer tap is **X1 to X2** **USE TABLE NINE**

If your transformer tap is **X1 to X3** **USE TABLE TEN**

If your transformer tap is **X1 to X4** **USE TABLE ELEVEN**

If your transformer tap is **X1 to X5** **USE TABLE TWELVE**

**DETERMINE THE LEVELING SPEED CURRENT LIMITING RESISTOR (Ohms)
FOR ISOLATION TRANSFORMER TAPS X1 TO X2 (110 VAC)**

FIELD VOLTAGE AT LEVELING SPEED (Volts DC)

FIELD (Amps)	5.00	6.00	7.00	8.00	9.00	10.00	11.00	12.00	13.00	14.00	15.00
0.05	3010.8	2990.8	2970.8	2950.8	2930.8	2910.8	2890.8	2870.8	2850.8	2830.8	2810.8
0.08	2007.2	1993.9	1980.5	1967.2	1953.9	1940.5	1927.2	1913.9	1900.5	1887.2	1873.9
0.10	1505.4	1495.4	1485.4	1475.4	1465.4	1455.4	1445.4	1435.4	1425.4	1415.4	1405.4
0.13	1204.3	1196.3	1188.3	1180.3	1172.3	1164.3	1156.3	1148.3	1140.3	1132.3	1124.3
0.15	1003.6	996.93	990.27	983.60	976.93	970.27	963.60	956.93	950.27	943.60	936.93
0.18	860.23	854.51	848.80	843.09	837.37	831.66	825.94	820.23	814.51	808.80	803.09
0.20	752.70	747.70	742.70	737.70	732.70	727.70	722.70	717.70	712.70	707.70	702.70
0.23	669.07	664.62	660.18	655.73	651.29	646.84	642.40	637.96	633.51	629.07	624.62
0.25	602.16	598.16	594.16	590.16	586.16	582.16	578.16	574.16	570.16	566.16	562.16
0.28	547.42	543.78	540.15	536.51	532.87	529.24	525.60	521.96	518.33	514.69	511.05
0.30	501.80	498.47	495.13	491.80	488.47	485.13	481.80	478.47	475.13	471.80	468.47
0.33	463.20	460.12	457.05	453.97	450.89	447.82	444.74	441.66	438.58	435.51	432.43
0.35	430.11	427.26	424.40	421.54	418.69	415.83	412.97	410.11	407.26	404.40	401.54
0.38	401.44	398.77	396.11	393.44	390.77	388.11	385.44	382.77	380.11	377.44	374.77
0.40	376.35	373.85	371.35	368.85	366.35	363.85	361.35	358.85	356.35	353.85	351.35
0.43	354.21	351.86	349.51	347.15	344.80	342.45	340.09	337.74	335.39	333.04	330.68
0.45	334.53	332.31	330.09	327.87	325.64	323.42	321.20	318.98	316.76	314.53	312.31
0.48	316.93	314.82	312.72	310.61	308.51	306.40	304.29	302.19	300.08	297.98	295.87
0.50	301.08	299.08	297.08	295.08	293.08	291.08	289.08	287.08	285.08	283.08	281.08
0.53	286.74	284.84	282.93	281.03	279.12	277.22	275.31	273.41	271.50	269.60	267.70
0.55	273.71	271.89	270.07	268.25	266.44	264.62	262.80	260.98	259.16	257.35	255.53
0.58	261.81	260.07	258.33	256.59	254.85	253.11	251.37	249.63	247.90	246.16	244.42
0.60	250.90	249.23	247.57	245.90	244.23	242.57	240.90	239.23	237.57	235.90	234.23
0.63	240.86	239.26	237.66	236.06	234.46	232.86	231.26	229.66	228.06	226.46	224.86
0.65	231.60	230.06	228.52	226.98	225.45	223.91	222.37	220.83	219.29	217.75	216.22
0.68	223.02	221.54	220.06	218.58	217.10	215.61	214.13	212.65	211.17	209.69	208.21
0.70	215.06	213.63	212.20	210.77	209.34	207.91	206.49	205.06	203.63	202.20	200.77

**DETERMINE THE LEVELING SPEED CURRENT LIMITING RESISTOR (Ohms)
FOR ISOLATION TRANSFORMER TAPS X1 TO X3 (130 VAC)**

FIELD VOLTAGE AT LEVELING SPEED (Volts DC)

FIELD (Amps)	8.00	9.00	10.00	11.00	12.00	13.00	14.00	15.00	16.00	17.00	18.00
0.05	3516.4	3496.4	3476.4	3456.4	3436.4	3416.4	3396.4	3376.4	3356.4	3336.4	3316.4
0.08	2344.3	2330.9	2317.6	2304.3	2290.9	2277.6	2264.3	2250.9	2237.6	2224.3	2210.9
0.10	1758.2	1748.2	1738.2	1728.2	1718.2	1708.2	1698.2	1688.2	1678.2	1668.2	1658.2
0.13	1406.6	1398.6	1390.6	1382.6	1374.6	1366.6	1358.6	1350.6	1342.6	1334.6	1326.6
0.15	1172.1	1165.5	1158.8	1152.1	1145.5	1138.8	1132.1	1125.5	1118.8	1112.1	1105.5
0.18	1004.7	998.97	993.26	987.54	981.83	976.11	970.40	964.69	958.97	953.26	947.54
0.20	879.10	874.10	869.10	864.10	859.10	854.10	849.10	844.10	839.10	834.10	829.10
0.23	781.42	776.98	772.53	768.09	763.64	759.20	754.76	750.31	745.87	741.42	736.98
0.25	703.28	699.28	695.28	691.28	687.28	683.28	679.28	675.28	671.28	667.28	663.28
0.28	639.35	635.71	632.07	628.44	624.80	621.16	617.53	613.89	610.25	606.62	602.98
0.30	586.07	582.73	579.40	576.07	572.73	569.40	566.07	562.73	559.40	556.07	552.73
0.33	540.98	537.91	534.83	531.75	528.68	525.60	522.52	519.45	516.37	513.29	510.22
0.35	502.34	499.49	496.63	493.77	490.91	488.06	485.20	482.34	479.49	476.63	473.77
0.38	468.85	466.19	463.52	460.85	458.19	455.52	452.85	450.19	447.52	444.85	442.19
0.40	439.55	437.05	434.55	432.05	429.55	427.05	424.55	422.05	419.55	417.05	414.55
0.43	413.69	411.34	408.99	406.64	404.28	401.93	399.58	397.22	394.87	392.52	390.16
0.45	390.71	388.49	386.27	384.04	381.82	379.60	377.38	375.16	372.93	370.71	368.49
0.48	370.15	368.04	365.94	363.83	361.73	359.62	357.52	355.41	353.31	351.20	349.09
0.50	351.64	349.64	347.64	345.64	343.64	341.64	339.64	337.64	335.64	333.64	331.64
0.53	334.90	332.99	331.09	329.18	327.28	325.37	323.47	321.56	319.66	317.75	315.85
0.55	319.67	317.85	316.04	314.22	312.40	310.58	308.76	306.95	305.13	303.31	301.49
0.58	305.77	304.03	302.30	300.56	298.82	297.08	295.34	293.60	291.86	290.12	288.38
0.60	293.03	291.37	289.70	288.03	286.37	284.70	283.03	281.37	279.70	278.03	276.37
0.63	281.31	279.71	278.11	276.51	274.91	273.31	271.71	270.11	268.51	266.91	265.31
0.65	270.49	268.95	267.42	265.88	264.34	262.80	261.26	259.72	258.18	256.65	255.11
0.68	260.47	258.99	257.51	256.03	254.55	253.07	251.59	250.10	248.62	247.14	245.66
0.70	251.17	249.74	248.31	246.89	245.46	244.03	242.60	241.17	239.74	238.31	236.89

**DETERMINE THE LEVELING SPEED CURRENT LIMITING RESISTOR (Ohms)
FOR ISOLATION TRANSFORMER TAPS X1 TO X4 (150 VAC)**

FIELD VOLTAGE AT LEVELING SPEED (Volts DC)

FIELD (Amps)	11.00	12.00	13.00	14.00	15.00	16.00	17.00	18.00	19.00	20.00	21.00
0.05	4022.0	4002.0	3982.0	3962.0	3942.0	3922.0	3902.0	3882.0	3862.0	3842.0	3822.0
0.08	2681.3	2668.0	2654.7	2641.3	2628.0	2614.7	2601.3	2588.0	2574.7	2561.3	2548.0
0.10	2011.0	2001.0	1991.0	1981.0	1971.0	1961.0	1951.0	1941.0	1931.0	1921.0	1911.0
0.13	1608.8	1600.8	1592.8	1584.8	1576.8	1568.8	1560.8	1552.8	1544.8	1536.8	1528.8
0.15	1340.7	1334.0	1327.3	1320.7	1314.0	1307.3	1300.7	1294.0	1287.3	1280.7	1274.0
0.18	1149.1	1143.4	1137.7	1132.0	1126.3	1120.6	1114.9	1109.1	1103.4	1097.7	1092.0
0.20	1005.5	1000.5	995.50	990.50	985.50	980.50	975.50	970.50	965.50	960.50	955.50
0.23	893.78	889.33	884.89	880.44	876.00	871.56	867.11	862.67	858.22	853.78	849.33
0.25	804.40	800.40	796.40	792.40	788.40	784.40	780.40	776.40	772.40	768.40	764.40
0.28	731.27	727.64	724.00	720.36	716.73	713.09	709.45	705.82	702.18	698.55	694.91
0.30	670.33	667.00	663.67	660.33	657.00	653.67	650.33	647.00	643.67	640.33	637.00
0.33	618.77	615.69	612.62	609.54	606.46	603.38	600.31	597.23	594.15	591.08	588.00
0.35	574.57	571.71	568.86	566.00	563.14	560.29	557.43	554.57	551.71	548.86	546.00
0.38	536.27	533.60	530.93	528.27	525.60	522.93	520.27	517.60	514.93	512.27	509.60
0.40	502.75	500.25	497.75	495.25	492.75	490.25	487.75	485.25	482.75	480.25	477.75
0.43	473.18	470.82	468.47	466.12	463.76	461.41	459.06	456.71	454.35	452.00	449.65
0.45	446.89	444.67	442.44	440.22	438.00	435.78	433.56	431.33	429.11	426.89	424.67
0.48	423.37	421.26	419.16	417.05	414.95	412.84	410.74	408.63	406.53	404.42	402.32
0.50	402.20	400.20	398.20	396.20	394.20	392.20	390.20	388.20	386.20	384.20	382.20
0.53	383.05	381.14	379.24	377.33	375.43	373.52	371.62	369.71	367.81	365.90	364.00
0.55	365.64	363.82	362.00	360.18	358.36	356.55	354.73	352.91	351.09	349.27	347.45
0.58	349.74	348.00	346.26	344.52	342.78	341.04	339.30	337.57	335.83	334.09	332.35
0.60	335.17	333.50	331.83	330.17	328.50	326.83	325.17	323.50	321.83	320.17	318.50
0.63	321.76	320.16	318.56	316.96	315.36	313.76	312.16	310.56	308.96	307.36	305.76
0.65	309.38	307.85	306.31	304.77	303.23	301.69	300.15	298.62	297.08	295.54	294.00
0.68	297.93	296.44	294.96	293.48	292.00	290.52	289.04	287.56	286.07	284.59	283.11
0.70	287.29	285.86	284.43	283.00	281.57	280.14	278.71	277.29	275.86	274.43	273.00

**DETERMINE THE LEVELING SPEED CURRENT LIMITING RESISTOR (Ohms)
FOR ISOLATION TRANSFORMER TAPS X1 TO X5 (165 VAC)**

FIELD VOLTAGE AT LEVELING SPEED (Volts DC)

FIELD (Amps)	15.00	16.00	17.00	18.00	19.00	20.00	21.00	22.00	23.00	24.00	25.00
0.05	4366.2	4346.2	4326.2	4306.2	4286.2	4266.2	4246.2	4226.2	4206.2	4186.2	4166.2
0.08	2910.8	2897.5	2884.1	2870.8	2857.5	2844.1	2830.8	2817.5	2804.1	2790.8	2777.5
0.10	2183.1	2173.1	2163.1	2153.1	2143.1	2133.1	2123.1	2113.1	2103.1	2093.1	2083.1
0.13	1746.5	1738.5	1730.5	1722.5	1714.5	1706.5	1698.5	1690.5	1682.5	1674.5	1666.5
0.15	1455.4	1448.7	1442.1	1435.4	1428.7	1422.1	1415.4	1408.7	1402.1	1395.4	1388.7
0.18	1247.5	1241.7	1236.1	1230.3	1224.6	1218.9	1213.2	1207.5	1201.8	1196.1	1190.3
0.20	1091.6	1086.6	1081.6	1076.6	1071.6	1066.6	1061.6	1056.6	1051.6	1046.6	1041.6
0.23	970.27	965.82	961.38	956.93	952.49	948.04	943.60	939.16	934.71	930.27	925.82
0.25	873.24	869.24	865.24	861.24	857.24	853.24	849.24	845.24	841.24	837.24	833.24
0.28	793.85	790.22	786.58	782.95	779.31	775.67	772.04	768.40	764.76	761.13	757.49
0.30	727.70	724.37	721.03	717.70	714.37	711.03	707.70	704.37	701.03	697.70	694.37
0.33	671.72	668.65	665.57	662.49	659.42	656.34	653.26	650.18	647.11	644.03	640.95
0.35	623.74	620.89	618.03	615.17	612.31	609.46	606.60	603.74	600.89	598.03	595.17
0.38	582.16	579.49	576.83	574.16	571.49	568.83	566.16	563.49	560.83	558.16	555.49
0.40	545.78	543.28	540.78	538.28	535.78	533.28	530.78	528.28	525.78	523.28	520.78
0.43	513.67	511.32	508.96	506.61	504.26	501.91	499.55	497.20	494.85	492.49	490.14
0.45	485.13	482.91	480.69	478.47	476.24	474.02	471.80	469.58	467.36	465.13	462.91
0.48	459.60	457.49	455.39	453.28	451.18	449.07	446.97	444.86	442.76	440.65	438.55
0.50	436.62	434.62	432.62	430.62	428.62	426.62	424.62	422.62	420.62	418.62	416.62
0.53	415.83	413.92	412.02	410.11	408.21	406.30	404.40	402.50	400.59	398.69	396.78
0.55	396.93	395.11	393.29	391.47	389.65	387.84	386.02	384.20	382.38	380.56	378.75
0.58	379.67	377.93	376.19	374.45	372.71	370.97	369.23	367.50	365.76	364.02	362.28
0.60	363.85	362.18	360.52	358.85	357.18	355.52	353.85	352.18	350.52	348.85	347.18
0.63	349.30	347.70	346.10	344.50	342.90	341.30	339.70	338.10	336.50	334.90	333.30
0.65	335.86	334.32	332.78	331.25	329.71	328.17	326.63	325.09	323.55	322.02	320.48
0.68	323.42	321.94	320.46	318.98	317.50	316.01	314.53	313.05	311.57	310.09	308.61
0.70	311.87	310.44	309.01	307.59	306.16	304.73	303.30	301.87	300.44	299.01	297.59

SUICIDE CIRCUIT

The suicide circuit disconnects the generator field from the controller and places the field across the Hoist Motor Armature. During the opening of the field contacts, any current flowing through the generator field must continue to flow. This will cause the contacts to arc until the field current decays.

It is absolutely necessary that the arcing is extinguished and the field contacts are completely open before the suicide contacts close. Any overlapping of these contacts will cause damage to the control. Therefore, the suicide contacts must be delayed in closing even under power loss conditions.

The suicide contacts should not be back, or auxiliary, contacts of the RUN relay since there will not be a sufficient time delay between the contacts making/braking.

The time delay will depend on the duration of the arc across the field contacts. For this reason, we have shown resistors **R2** and **R4** in the hook-up print, across the field contacts to permit some current flow during the opening of the **RUN** contacts. **R2** and **R4** will provide a discharge path through the control for the field current, preventing damage to the control caused by the closing of the suicide contact.

SECTION SIX

TROUBLESHOOTING

The following pages contain tables which list common problems that may be encountered during set up and operation of the model D1025 MKII Bi-Directional Generator Field Control. The probable cause column contains the most likely reason for the problem. The corrective action column contains steps, which may be taken to correct the problem.



THE BI-DIRECTIONAL FIELD REGULATOR SHOULD BE INSTALLED, ADJUSTED AND SERVICED BY QUALIFIED ELECTRICAL MAINTENANCE PERSONNEL FAMILIAR WITH THE CONSTRUCTION AND OPERATION OF ALL EQUIPMENT IN THE ELEVATOR SYSTEM; PERSONAL INJURY AND/OR EQUIPMENT DAMAGE MAY OCCUR IF INDIVIDUALS ARE NOT FAMILIAR WITH THE HAZARDS RESULTING FROM IMPROPER OPERATION.



CONTROLLER EQUIPMENT IS AT LINE VOLTAGE WHEN AC POWER IS CONNECTED AND INTERNAL CAPACITORS REMAIN CHARGED AFTER POWER IS REMOVED FROM THE BI-DIRECTIONAL FIELD REGULATOR. IT IS IMPORTANT THAT AC POWER IS REMOVED FROM THE UNIT FOR A MINIMUM OF FIVE MINUTES BEFORE IT IS SAFE TO TOUCH THE INTERNAL PARTS OF THE CONTROL. PERSONAL INJURY MAY RESULT UNLESS POWER IS REMOVED.



THE USER IS RESPONSIBLE FOR CONFORMING TO THE NATIONAL ELECTRICAL CODE WITH RESPECT TO MOTOR, CONTROLLER AND OPERATOR DEVICE INSTALLATION, WIRING AND START UP. THE USER IS ALSO RESPONSIBLE FOR UNDERSTANDING AND APPLYING ALL OTHER APPLICABLE LOCAL CODES, WHICH GOVERN SUCH PRACTICES AS WIRING PROTECTION, GROUNDING, DISCONNECTS AND OVERCURRENT PROTECTION.

PROBLEM	PROBABLE CAUSE	CORRECTIVE ACTION
CONTROL TRIPS ON DIRECTION FAULT	Tachometer wiring error	Check the tachometer wiring. The tachometer signal at the TACH testpoint should be positive when the car is traveling in the UP direction.
	Long delay between the Brake lifting and RUN signal application is causing the elevator to roll back before accelerating away from the floor.	Correct the controller logic to remove delays between the picking of the brake and the application of the RUN signal.
	Rapid reversal of the Elevator Car direction prior to stopping	Releveling before the car has stopped will cause a direction fault. Correct the controller logic as required.
CONTROL TRIPS ON TACH LOSS	Tachometer signal is not present or intermittent	Check the mechanical and electrical connections of the tachometer.
	The tachometer feedback signal is the wrong polarity or too small.	Spin the tachometer by hand and measure the voltage at the TACH+ and TACH- terminals at J2. The voltage should increase as the tachometer spins faster. The polarity of the tachometer voltage should reverse as the tachometer is spun in the opposite direction. Verify that the tachometer feedback signal at the TACH testpoint is positive in the UP direction and is 10 volts at contract speed.
	The Armature Feedback voltage is set too high.	Too much Armature Feedback will make the TACH LOSS circuit too sensitive. Re-adjust the Armature Feedback potentiometer for 7.5 volts on the ARM FB testpoint at contract speed.
	The picking of the brake is delayed during take off from the floor	If the Armature Feedback voltage is allowed to build up before the tachometer starts turning, the control will trip on TACH LOSS. Check controller logic and brake release.

PROBLEM	PROBABLE CAUSE	CORRECTIVE ACTION
CONTROL TRIPS ON OVERSPEED	The tachometer feedback voltage has exceeded the reference voltage	Compare the signal at the TACH testpoint to the REF OUT testpoint. The TACH testpoint should never go higher than 10 volts and should not exceed the REF OUT voltage. Test in both UP and DN directions
	Weak Hoist Motor Field	If you are using field weakening at contract speed, remove it and try running at contract speed. If no trip occurs, you are weakening too much. Also, the weakening of the field should occur after the REF OUT testpoint has passed the ACC END knee and leveled out, otherwise you may get a surge (bump) at the ACC END knee which will cause a trip.
	The CONTRACT SPD potentiometer is set too low	Adjust the CONTRACT SPD potentiometer to obtain contract speed exactly. The TACH testpoint should read 10 volts when running at contract speed.
	Loose tachometer connection or tachometer wheel is skipping / slipping.	Ensure that the tachometer is mounted securely. Check the coupling of the tachometer to the motor, or the connection to the roller wheel. Make sure that the surface that the roller wheel rides upon is smooth and free from bumps. Make sure that the tachometer mount places enough pressure on the roller wheel to keep it on the surface it is reading.
CONTROL TRIPS ON POWER BOARD TRIP AT CONTRACT SPEED	The Generator Field resistance is too low.	The minimum resistance of the generator field must be 21 ohms or greater (measured at F+ and F- on TB2). Run the car at a lower speed and see if the trip occurs. If the field resistance is too low, either rewire the fields or add resistance in series with the field. If possible step down to the next lower transformer tap.

PROBLEM	PROBABLE CAUSE	CORRECTIVE ACTION
	Contract speed is being exceeded	Measure the speed of the car with a hand held tachometer. Adjust the CONTRACT SPD pot as required.
CONTROL TRIPS ON POWER BOARD TRIP AT LOW END OF A RUN	Insufficient delay exists when the suicide circuit closes.	Ensure that an adequate delay exists between the dropping of the RUN contacts and the making of the suicide contacts.
	Incorrect control or power wiring	Check all control and power connections against the hook-up diagram.
	Field wiring is shorted to ground	Check the Generator Field wiring for shorts to ground.
NO OUTPUT FROM CONTROL	Input wiring error	Ensure that the proper control voltages exist at the D1025 MKII. Check all fuses.
	Bad connection at the Field Power connections.	If the Field Power indicator is not lit, check all connections that supply field power. Check the field power fuse, F1.
	A fault trip condition exists and the control is disabled.	Check the Fault Conditions indicators to see if a fault condition is present. Reset the control and correct the fault if it reoccurs.
	Wiring fault in the Generator	Measure the control output voltage at the F+ and F- terminals. If a voltage is present, the control is operating properly. Check for a voltage directly at the Generator Field.
CANNOT ACHIEVE CONTRACT SPEED	Too much series resistance (R3)	Lower the resistance of the high-speed current limiting resistor R3 (see hook-up).

PROBLEM	PROBABLE CAUSE	CORRECTIVE ACTION
	Ripple/Noise on the tachometer signal.	Look at the signal at the TACH testpoint with an oscilloscope. The signal should be clean with no ripple at all. Any ripple shown indicates either electrical or mechanically induced noise. Check the tachometer connections, both electrical and mechanical for areas where noise could be introduced, such as improper alignment, tachometer wires next to power wires etc.
ELEVATOR IS UNSTABLE AT HIGH SPEED	Armature feedback is connected backwards	Check the voltage at the ARM FB testpoint. The voltage should be positive in the UP direction and negative in the DN direction. Reverse the leads at TB1 if the polarities are reversed (see hook-up).
	The armature feedback signal is misadjusted	Set the armature feedback signal to 7.5 volts at the ARM FB testpoint when the car is running at contract speed. If the car is still unstable, reduce the STABILITY GAIN potentiometer until the ride improves.
CAR OVERSHOOTS CONTRACT SPEED DURING ACCELERATION	Too much gain	Turn the LOOP GAIN potentiometer counterclockwise to reduce the gain
	Acceleration rates are set too fast	Reduce the acceleration rates.
	Motor field too weak	Weakening the motor field too much will cause the car to overshoot contract speed. Increase the motor field voltage
SLOW RESPONSE AT HIGH SPEED	Not enough gain	Increase the gain by turning the LOOP GAIN potentiometer clockwise.
	Too much stability gain	Reduce the stability gain by turning the STABILITY potentiometer counterclockwise

PROBLEM	PROBABLE CAUSE	CORRECTIVE ACTION
	Too much armature feedback	Reduce the armature feedback by turning the ARM FEEDBACK potentiometer counterclockwise
	Not enough current	Increase the available current by stepping up to the next higher tap on the field power transformer.
UP AND DOWN SPEEDS ARE NOT EQUAL	The control is out of regulation in the slower direction due to insufficient current available.	Reduce the series resistance, R3, to increase current to the generator field. If this does not work, step up to the next higher tap on the field power transformer.
	The control is in the SET UP mode	The UP and DN speeds will not be accurate when the control is in the SET UP mode because there is no tachometer feedback signal in this mode. Switch to AUTO mode (J4).
OUT OF REGULATION LIGHT FLICKERS OR STAYS ON	Noise on the armature feedback or tachometer signals	Check the mechanical and electrical connections for both the tachometer and the armature feedback.
	The CONTRACT SPD potentiometer is misadjusted	Adjust the CONTRACT SPD potentiometer until the TACH testpoint reads 10 volts at contract speed
	Armature feedback signal is set too high	Ensure that the armature feedback signal never exceeds 10 volts at contract speed. Readjust the ARM FEEDBACK potentiometer as necessary
INSTABILITY AT LOW SPEED / DECELERATING INTO THE FLOOR	Deceleration rates are too fast	Decrease the deceleration rates.
	The stability gain is set too high	Reduce the stability gain by turning the STABILITY GAIN potentiometer counterclockwise. Reset to the previous setting if this has no effect

PROBLEM	PROBABLE CAUSE	CORRECTIVE ACTION
	Armature feedback signal is set too high	Decrease the armature feedback signal by turning the ARM FEEDBACK potentiometer counterclockwise. Do not decrease the signal at the ARM FB testpoint below 4 volts. Increase the STABILITY GAIN potentiometer if high-speed instability occurs with the lowered armature feedback signal.
	The reference voltage is too far ahead of the tachometer feedback signal	Make sure that the motor field is not being forced too much. This will reduce the speed that the motor can spin at for a given voltage at the REF OUT testpoint. Remove field forcing to see if condition improves
THE CAR STOPS TOO HARD / OSCILLATES AROUND ZERO SPEED	The Hoist motor field is being weakened before reaching a complete stop	Make sure that the motor field is not weakened until the motor has completely stopped and the brake is set
	The STOP DELAY time is too short	Increase the length of the STOP DELAY by turning the STOP DELAY potentiometer counterclockwise

TYPICAL LOGIC SELECTION FOR BI-DIRECTIONAL APPLICATION

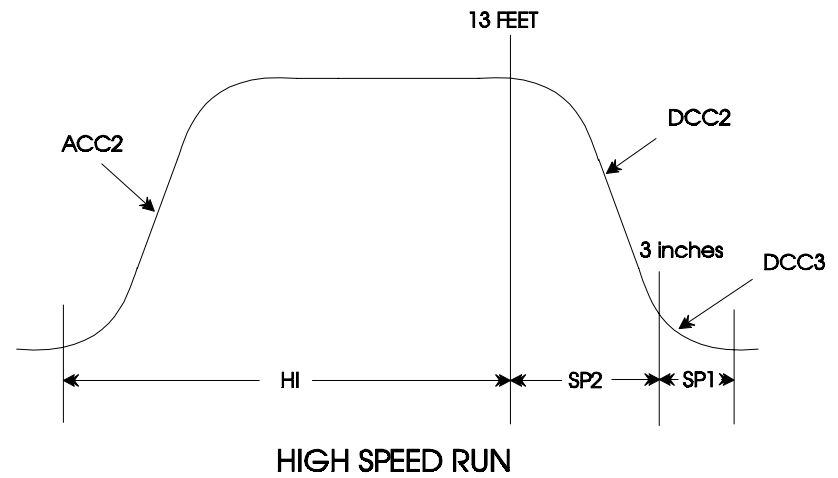
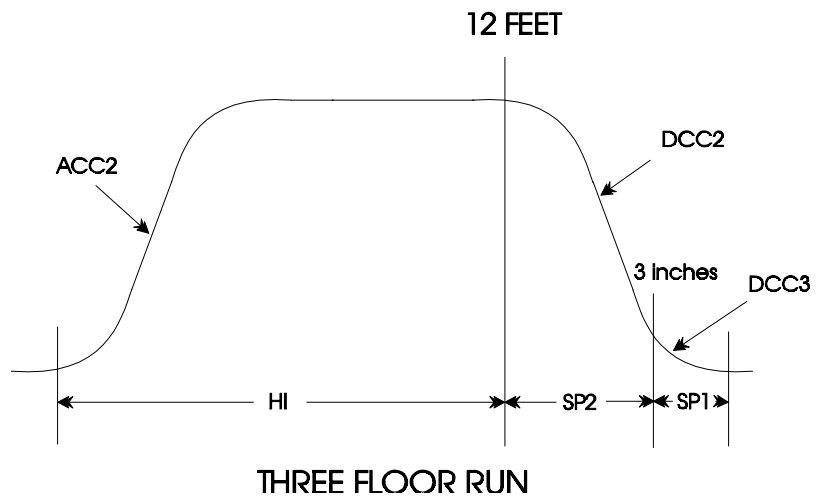
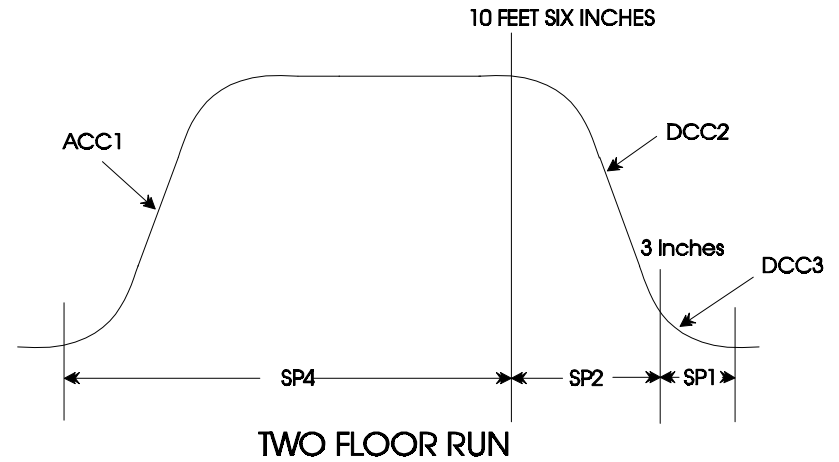
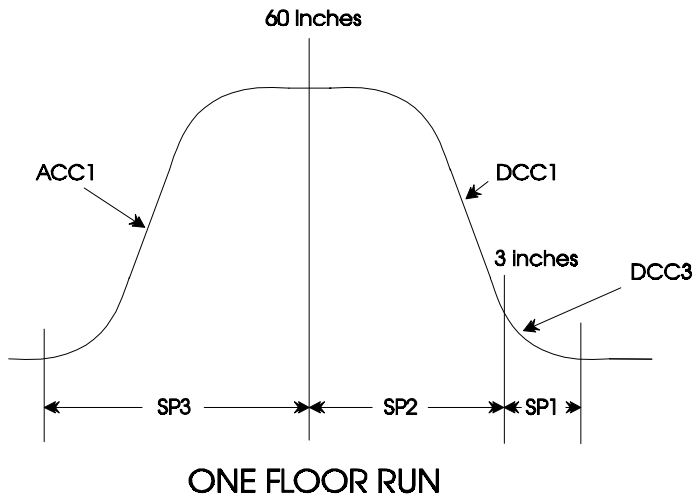

REVISIONS					
ECN	REV	DESCRIPTION	CHECKED	DATE	APPROVED
1002	1	Updated to match new layout	RCJ	1/21/00	WJS

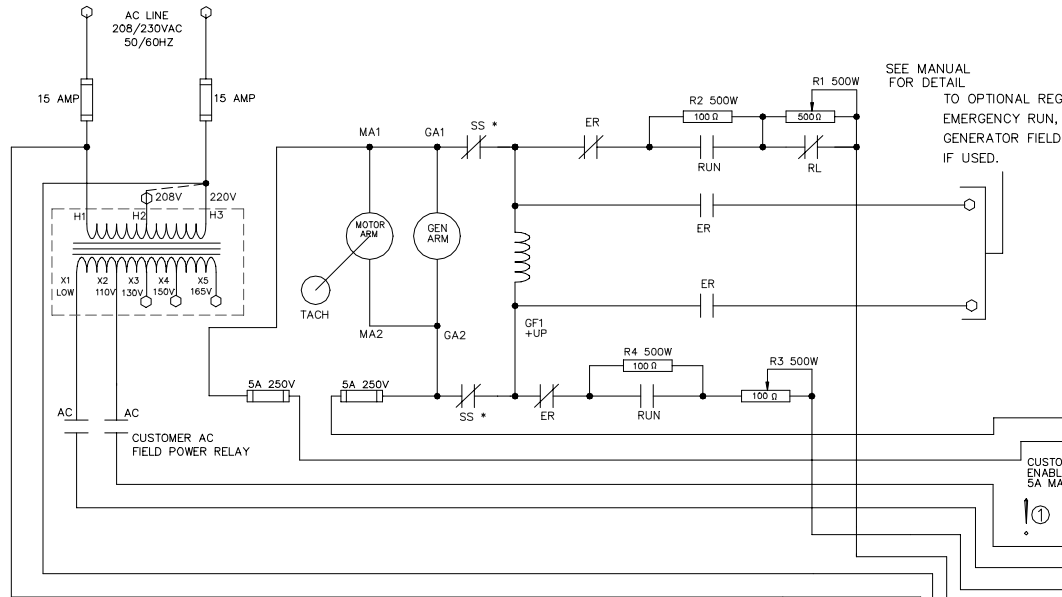

SEE MANUAL FOR DETAIL
TO OPTIONAL REGULATOR LOSS, EMERGENCY RUN, ALTERNATE GENERATOR FIELD SUPPLY IF USED.

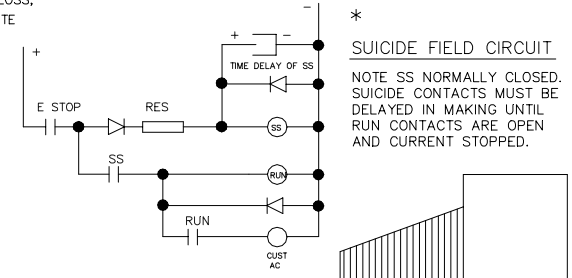

* SUICIDE FIELD CIRCUIT
NOTE SS NORMALLY CLOSED. SUICIDE CONTACTS MUST BE DELAYED IN MAKING UNTIL RUN CONTACTS ARE OPEN AND CURRENT STOPPED.

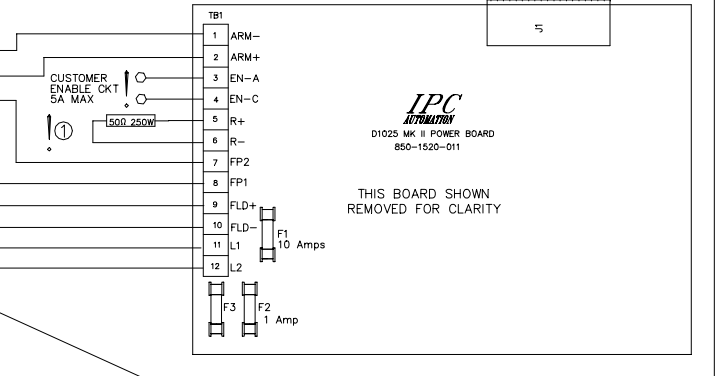

IPC
AUTOMATION
D1025 MK II POWER BOARD
850-1520-011
THIS BOARD SHOWN REMOVED FOR CLARITY

! THIS RESISTOR 50 Ω 250W MUST BE CONNECTED. FAILURE TO DO SO WILL RESULT IN DAMAGE OF THE CONTROL.

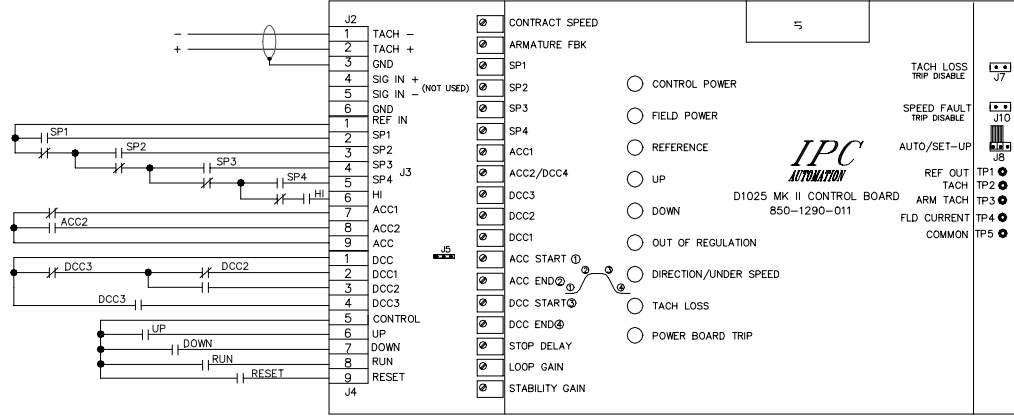

- CONTRACT SPEED
- ARMATURE FBK
- SP1
- SP2
- SP3
- SP4
- ACC1
- ACC2/DCC4
- DCC3
- DCC2
- DCC1
- ACC START
- ACC END
- DCC START
- DCC END
- STOP DELAY
- LOOP GAIN
- STABILITY GAIN
- CONTROL POWER
- FIELD POWER
- REFERENCE
- UP
- DOWN
- OUT OF REGULATION
- DIRECTION/UNDER SPEED
- TACH LOSS
- POWER BOARD TRIP
- TACH LOSS TRIP DISABLE (J7)
- SPEED FAULT TRIP DISABLE (J10)
- AUTO/SET-UP (J8)
- REF OUT (TP1)
- TACH (TP2)
- ARM TACH (TP3)
- FLD CURRENT (TP4)
- COMMON (TP5)

IPC
AUTOMATION
D1025 MK II CONTROL BOARD
850-1290-011

UNLESS OTHERWISE SPECIFIED:
TOLERANCES:
ANGULAR ±1/2"
TWO PLACE DECIMAL ±.01
THREE PLACE DECIMAL ±.005
FINISH SURFACES 125 RMS
BREAK SHARP CORNERS .01/.02 R.
MATERIAL:
FINISH:
DRAWN *RCJ* DATE 2/20/97
CHECKED *RCJ* DATE 2/24/97
APPROVED *WJS* DATE 2/24/97

IPC 441 INDUSTRIAL DRIVE
AUTOMATION LEXINGTON, SC 29072

D1025 MK II BIDIRECTIONAL
CONTROL HOOK UP DIAGRAM

FILE NO.	S-276	REV	1
D1025 MK II		SCALE	1/2
SHEET . 1		OF 1	

HOOKUP DIAGRAM